



IP-9610

Hardware User's Guide



(This page is intentionally left blank)

USING IP-9610 SAFELY

Handling of This Manual

The manual contains important information regarding the safe use of IP-9610. Read it thoroughly before operating this device. Make sure that users of the device read and understand thoroughly all safety precautions contained in the manual. Keep this manual in a safe and convenient location for quick reference.

Fujitsu makes every effort to prevent users and bystanders from injury and to prevent property damage. To ensure no harm to you and bystanders, and to prevent damage to the device itself, be sure to use this equipment in accordance with instructions in the manual.

The following notice is for USA users only.

IP-9610 has been tested and found to comply with the limits for a Class A digital device, pursuant to Part 15 of the FCC Rules. These limits are designed to provide reasonable protection against harmful interference when the equipment is operated in a commercial environment. This equipment generates, uses, and can radiate radio frequency energy and, if not installed and used in accordance with the instruction manual, may cause harmful interference to radio communications. Operation of this equipment in a residential area is likely to cause harmful interference in which case the user will be required to correct the interference at his own expense.

The following notice is for Canada users only.

This Class A digital apparatus meets all requirements of the Canadian Interference-Causing Equipment Regulations.

The following notice is for EU (European Union) users only.

This is Class A product of Electromagnetic Interference (EMI) standard. In a domestic environment this product may cause radio interference in which case the user may be required to make adequate measures.

This manual includes technology controlled under the Foreign Exchange and Foreign Trade Control Law of Japan. The manual or a portion thereof must not be exported (or re-exported) without authorization from the appropriate governmental authorities in accordance with the above law.

IP-9610 is designed and manufactured for use in standard applications such as office work, personal devices, and household appliances. The product is not intended for special uses (such as nuclear-reactor control in atomic energy facilities, aeronautic and space systems, air traffic control, operation control in mass transit systems, medical devices for life support, and missile firing controls in weapons facilities) where particularly high reliability requirements exist, where the pertinent levels of safety are not guaranteed, or where a failure or operational error could threaten a life or cause physical injury (hereafter referred to as "mission-critical" use). Customers considering use of this product for mission-critical applications must have safety-assurance measures in place beforehand. Moreover, they are requested to consult our sales representative before embarking on such specialized use.

Copying of and disassembly, decompilation and other forms of reverse engineering of any program included with this device is prohibited.

Windows, Internet Explorer are registered trademarks or trademarks of Microsoft Corporation in the United States and/or other countries.

IMPORTANT NOTE TO USERS

READ THE ENTIRE MANUAL CAREFULLY BEFORE USING THIS PRODUCT. INCORRECT USE OF THE PRODUCT MAY RESULT IN INJURY OR DAMAGE TO USERS, BYSTANDERS OR PROPERTY.

While FUJITSU has sought to ensure the accuracy of all information in this manual, FUJITSU assumes no liability to any party for any damage caused by any error or omission contained in this manual, its updates or supplements, whether such errors or omissions result from negligence, accident, or any other cause. In addition, FUJITSU assumes no liability with respect to the application or use of any product or system in accordance with descriptions or instructions contained herein; including any liability for incidental or consequential damages arising therefrom.

FUJITSU DISCLAIMS ALL WARRANTIES REGARDING THE INFORMATION CONTAINED HEREIN, WHETHER EXPRESSED, IMPLIED, OR STATUTORY.

FUJITSU reserves the right to make changes to any products described herein without further notice and without obligation.

No part of this manual shall be reproduced in any way or form without the permission of Fujitsu Limited.

All Rights Reserved. Copyright © FUJITSU LIMITED 2011

PREFACE

Thank you for purchasing the IP-9610(H264/AVC CODEC).

IP-9610 are the video transmission unit with the H.264 encoding technology.

This manual explains how to use hardware for IP-9610.

This manual is intended for system designers and system managers who use IP-9610. Readers are assumed to have a basic knowledge of networks and video distribution.

November 2011 1st Edition

Product operating environment

- Designed for use in real-time audio/video transmission systems and in the transmission system of monitoring systems, IP-9610 is intended for indoor use.

Note:

The contents of this manual are subject to change without notice.

ORGANIZATION AND CONTENTS OF THIS MANUAL

The manual consists of five chapters, an appendix, a glossary and an index.

Read Chapters 1 and 2 first for information on installing and connecting the device. Read Chapter 3 for operating instructions, and Chapter 4 and subsequent chapters can be read as required.

Chapter 1 Preparations

This chapter describes the checks that are required before the start of IP-9610 operation.

Chapter 2 Installation and Connection

This chapter describes conditions for IP-9610 installation and explains how to connect it to peripheral the devices.

Chapter 3 Operating Instructions

This chapter explains how to power on/off, set up and operate the device.

Chapter 4 Connection Cable Specifications

This chapter contains a classification of how work is implemented, cable connection system diagrams and cable connector details.

Chapter 5 Troubleshooting

This chapter describes actions to be taken if the device does not operate normally or if an alarm LED turns on.

Appendix

The appendix contains views of the device and its basic specifications. Installation work and on-site adjustment preparations are also covered in this section.

Glossary

The glossary defines the technical terms used in this manual.

Index

The index lists keywords and corresponding pages on which the words appear, so necessary items can be looked up immediately.

WARNING INDICATIONS

This manual uses warning indications to warn of conditions in order to prevent serious injury and property damage. Warning indications consist of warning markings of specific levels and warning messages. The warning markings are shown below along with their definitions.



⚠ WARNING indicates a situation that could lead to serious injury or loss of life if procedures are not followed correctly.



⚠ CAUTION indicates a situation that could lead to minor or moderate injury and/or damage to the device itself if procedures are not followed correctly.

Warning indications within text

Warning markings are followed by warning messages. Every warning marking is centered on a line. Left and right indents are set for warning messages to differentiate them from ordinary text. Furthermore, the lines immediately before and after warning indications are left blank.

(Example)



Possibility of electric shock, fire and damage to the device

Always observe the precautions given below.

This indicates a hazardous situation that could lead to electric shock, fire or damage to the device.

- Always connect the power cord to a power receptacle for a standard two-prong plug with ground.
- Connect the device to the power receptacle with a capacity of 1A or more. When using a power extension cable, be sure that the total power consumption of all devices connected to the cable does not exceed the rated capacity of the cable. If a power receptacle with a low capacity or capacity below the rated value is used, the power receptacle, extension cable or power distribution wiring may overheat and start a fire.

Important warning indications are summarized below in “Safety Precautions.”

SAFETY PRECAUTIONS

List of important warnings

The table below contains a list of important warning indications.

 WARNING	Indicates a situation that could lead to serious injury or loss of life if procedures are not followed correctly.
--	---

Work type	Warning
Normal use	<p>Possibility of electric shock and fire If an excessive heat, smoke, an abnormal odor or an unusual noise is coming from the device, immediately set its power switch to OFF and remove the power cord plug from the power receptacle. Then, contact a Fujitsu Service Center. This indicates a hazardous situation that could lead to fire and electric shock.</p> <p>Possibility of electric shock and fire If foreign matter (e.g., water, bits of metal, fluid) gets inside the device, immediately set its power switch to OFF and remove the power cord plug from the power receptacle. Then, contact a Fujitsu Service Center. This indicates a hazardous situation that could lead to fire and electric shock.</p> <p>Possibility of electric shock and fire If the device has been dropped or otherwise damaged, immediately set its power switch to OFF and remove the power cord plug from the power receptacle. Then, contact a Fujitsu Service Center. This indicates a hazardous situation that could lead to electric shock.</p> <p>Possibility of electric shock and fire To keep foreign matter out, ensure that drink containers and metal objects are not placed on or near the device. The presence of foreign matter such as water inside the device creates a hazardous situation that could lead to electric shock.</p> <p>Possibility of electric shock and fire Ensure that no liquid is splashed on the device, making it wet. The presence of foreign matter such as water inside the device creates a hazardous situation that could lead to fire and electric shock.</p> <p>Possibility of electric shock and fire Ensure that the power cord does not become damaged, and avoid tampering with it. If the power cord has a heavy object is placed on it, pulled at, bent, or becomes entangled, it could be damaged as a result. Also, the power cord could be damaged if subjected to heat, creating a hazardous situation that could lead to fire and electric shock.</p> <p>Possibility of electric shock Because this device contains a hazardous voltage section, never open the cover. Only a service engineer must open the cover. This warning indicates a hazardous situation that could lead to electric shock.</p>

Work type	Warning
Installation	<p data-bbox="430 280 890 313">Possibility of electric shock and fire</p> <p data-bbox="430 320 1497 394">Do not install the device in the following places because using it there may cause a fire or electric shock:</p> <ul data-bbox="459 405 1497 768" style="list-style-type: none"> <li data-bbox="459 405 855 439">• Extremely dusty or dirty place <li data-bbox="459 448 762 481">• Wet or humid location <li data-bbox="459 490 1497 564">• Hot location, such as a place where the device is exposed to direct sunlight or is near heating equipment <li data-bbox="459 573 1289 607">• Near products (e.g., speakers) that generate a strong magnetic field <li data-bbox="459 616 1082 649">• Location where the temperature is too hot or cold <li data-bbox="459 658 1139 692">• In an environment with sharp temperature fluctuations <li data-bbox="459 701 810 734">• Area with poor ventilation <li data-bbox="459 743 625 777">• Near a fire <p data-bbox="430 815 1197 848">Possibility of electric shock, fire, and damage to the device</p> <p data-bbox="430 855 967 889">Always observe the precautions given below.</p> <p data-bbox="430 893 1497 954">This indicates a hazardous situation that could lead to electric shock, fire and damage to the device.</p> <ul data-bbox="459 963 1497 1191" style="list-style-type: none"> <li data-bbox="459 963 1497 1023">• Always connect the power plug to a power receptacle for a standard two-prong plug with ground. <li data-bbox="459 1032 1497 1191">• Connect the device to a power receptacle with a capacity of 1 A or more. When using a power extension cable, be sure that the total current consumption of all devices connected to the cable does not exceed the rated capacity of the cable. If a power receptacle with a low capacity or capacity below the rated value is used, the power receptacle, extension cable or power wiring may overheat and start a fire.

Work type	Warning
Installation and relocation	<p>Possibility of serious injury and damage to the device Do not install the device in places where it is exposed to shock and strong vibrations, on an incline or in unstable locations.</p> <p>This indicates a hazardous situation that could lead to serious injury or damage to the device.</p> <p>Possibility of serious injury and damage to the device When relocating the device, observe the following precautions to protect against serious injury and damage to the device:</p> <ul style="list-style-type: none"> • Set the power switch to OFF, and disconnect all connected cables. Take care to avoid getting your feet entangled in the cables. • To prevent serious personal injury when moving the device, take special care to pay attention to your surroundings.
Clean	<p>Possibility of fire, serious injury and damage to the device When cleaning the device, observe the following precautions to protect against fire, serious injury and damage to the device:</p> <ul style="list-style-type: none"> • When cleaning the device, please do not use cleaning spray that is including combustible material. Also, please do not use it around the device. • When cleaning the device, please wipe off with the cloth squeezing water (or neutral detergent thinned by water). • When wiping off, please be careful not to put water into the device from switches or the spaces.

LABEL

The warning label shown below is affixed to the device.

- Never remove the label.
- Be sure to check the label at the bottom of this device before coming to the power supply.
- The following label is intended for users of the device s.

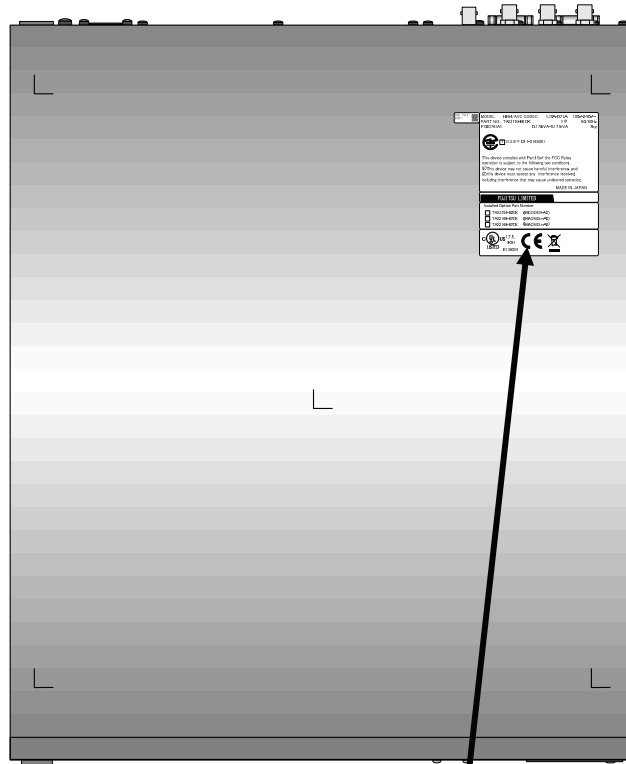

01A 11-11 00001		MODEL H264/AVC CODEC 1.70A-0.71A 100V-240V~	PART NO. TA23793-B10X 1 φ 50/60Hz	FC40761A1 0.170kVA-0.171kVA 7kg
		認証番号 D11-0165001		
<p>This device complies with Part 15 of the FCC Rules. operation is subject to the following two conditions: (1) This device may not cause harmful interference. and (2) this device must accept any interference received, including interference that may cause undesired operation.</p> <p style="text-align: right;">MADE IN JAPAN</p>				
FUJITSU LIMITED				
Installed Option Part Number <input type="checkbox"/> TA23793-B20X (96CODES-A0) <input type="checkbox"/> TA22168-B70X (96ACMDL-A0) <input type="checkbox"/> TA22168-B70X (96ACMDL-A0)				
US I.T.E. 1K91 LISTED E136004				

PRODUCT HANDLING PRECAUTIONS

Maintenance

WARNING

Do not try to repair the device yourself. Contact a Fujitsu Service Center.

CAUTION

Read this manual thoroughly before attempting to operate the device.
If you have any questions, contact a Fujitsu Service Center.

If a problem occurs, contact a Fujitsu Service Center.
The Fujitsu Service Center will ask you to describe the problem, the lamp display status of alarm LEDs and other details. Check the system for this information.

Connectable devices

Only devices that conform to the device interface specifications (see Appendix 2.3, "Device Specifications") can be connected. Otherwise, if incompatible devices are connected, the result may be personal injury and property damage.

Disposal

To dispose of the device, contact a Fujitsu Service Center, or request a specialist to take care its disposal.

Modification and restoration

Do not use any device that has been modified or rebuilt with refurbished used parts. Doing so may result in personal injury and property damage.

CONTENTS

USING IP-9610 SAFELY	i
PREFACE	iii
ORGANIZATION AND CONTENTS OF THIS MANUAL.....	iv
WARNING INDICATIONS.....	v
SAFETY PRECAUTIONS	vi
LABEL	ix
PRODUCT HANDLING PRECAUTIONS	x
Chapter 1 Preparations.....	1
1.1 Main Features	3
1.2 Components.....	5
1.3 Basic Application Examples	6
1.4 Part Names	7
Chapter 2 Installation and Connection.....	11
2.1 Installation Conditions	13
2.1.1 Environment conditions	13
2.1.2 Installation environment.....	13
2.1.3 Air flow into and out from the device	16
2.1.4 Open space required around the device.....	17
2.2 Power Supply System Connections.....	18
2.2.1 Connection to ground	18
2.2.2 Connection to power source.....	19
2.3 Connection to External Sync(REF)	22
2.4 Connection to DVB-ASI Device.....	23
2.4.1 Connection to DVB-ASI Input Device	23
2.4.2 Connection to DVB-ASI Output Device	24
2.5 Connection to RS-232C/RS-422 Device.....	25
2.6 Connection to Network.....	26
2.7 Connection to Voice Communication (Intercom)	27
2.8 Optional Board Slot.....	28
Chapter 3 Operation Instructions	29
3.1 Power ON/OFF	31
3.1.1 Powering on	31
3.1.2 Powering off	31
3.2 Device Settings and Operation	32
3.3 Device Settings and Operation (Front Panel).....	33
3.4 Special Use of Cancel Key	34
Chapter 4 Cable Specifications.....	35
4.1 Installation Preparations.....	37
4.2 Cable and Connector Details	38

Chapter 5 Troubleshooting	45
5.1 Help Information	47
5.2 Alarm LED Lamp Is On	49
5.3 Maintenance	50
5.3.1 Maintenance space	50
5.3.2 Change of maintenance parts (Maintenance only)	51
Appendix.....	53
A.1 Appearance	55
A.2 Basic Specifications	57
A.2.1 External specifications	57
A.2.2 Environment specifications	57
A.2.3 Function specifications	58
A.3 Preparations for Installation Work	62
A.3.1 Scope of installation work	62
A.3.2 Unpacking and device check	62
A.3.3 Installation conditions	62
A.3.4 Connecting external cables	62
A.4 Preparations for On-site Turn-up	63
Glossary and Index	67
Glossary	69
Index	72
CE Conformity Information	74

CHAPTER 1

PREPARATIONS

This chapter describes the checks that are required before the start of IP-9610 operation.

1.1	Main Features	3
1.2	Components	5
1.3	Basic Application Examples	6
1.4	Part Names	7

(This page is intentionally left blank)

1.1

Main Features

IP-9610 are the video transmission unit with the H.264 encoding technology.

Supports H.264 4:2:2 10 bit 1080p video, delivering high quality video encoding.

1U main equipment can hold two codec boards, supporting up to two channels of video encoding.

Scalable equipment enables configurations matching your operation scenarios to make it possible by combining SDI Input/Output Board and option licenses.

Equipment can be operated from the Web GUI, front panel, or SNMP, providing high operability.

By combining the base equipment and hardware options, you can initially assemble the required functions in the IP-9610. You can flexibly configure the IP-9610 by selecting the SDI input board to have the equipment function as an encoder, or selecting the SDI output board to have the equipment function as a decoder. Also, you can add the Audio Board to use the 16 channel audio function.

And, to operate this equipment, you need to purchase a software license key and activate it.

For details, see the software manuals

Main Features

Item	Specifications			Remarks
Video input	HD-SDI / SD-SDI	2ch(max)	[BNC]	Located at option slot #1~#4
Video output	HD-SDI / SD-SDI	8ch(max)	[BNC]	Located at option slot #1~#4
Audio input	HD-SDI embedded	16ch(max)	[BNC], 8 stereo pairs	Located at option slot #1~#4
Audio output	HD-SDI embedded	16ch(max)	[BNC], 8 stereo pairs	Located at option slot #1~#4
Reference clock input	Analog Composite 75Ω or Component 75Ω	1ch	[BNC]	
Reference clock output	Analog Composite 75Ω or Component 75Ω	1ch	[BNC]	
Voice input/output	Analog balanced 600Ω	1ch	[RJ25]	
Network	LAN	3ch	[RJ45], 10BASE-T/100BASE-TX /1000BASE-T	
Data input/output	RS-232C	2ch	[D-sub9-pin] male connector	
SD CARD slot	SD CARD	1	For maintenance use	Future Support
USB	USB Interface	1	For maintenance use	Future Support
Installation conditions	Indoor: On a desk, mounted in a rack			
Dimensions	W: 425 H: 42 D: 350 (mm) Note: Excluding protrusions W: 425 H: 46 D: 520.3 (mm) Note: Including optional board, etc			
Cooling system	Forced air cooling			
Power supply	100-240VAC			
Weight	Maximum 7kg			
Power consumption	170VA or less (100V AC) 171VA or less (240V AC)			
Temperature	0 to 50°C			
Humidity	20 to 90%RH (No condensing)			

Hardware option	Maximum installation	Description
SDI input board	4	Installed according to the number of SDI inputs/outputs. Combining two SDI input boards or two SDI output boards enables support for dual-link SDI.
SDI output board		
Codec board (*1)	2	A codec board is always installed in the base equipment. Installing one additional board enables the following operation modes (*3): Encoder x 2 Decoder x 2 Encoder x 1 and Decoder x 1 Decoder x 1 and Encoder x 1
Audio board (*2)	2	With a Codec Board, this board enables support of the 16 channels audio (stereo pairs of 8 channels) function.

*1 The codec board has an 8 channel audio function.

*2 If two codec boards are installed, an audio board must be added to each of these codec boards (two audio boards must be added).

*3 For details on combinations of operation modes and the AV input-output interfaces, refer **Appendix 5 AV Interface Settings** the IP-9610 Software User's Guide. It is necessary to install a software license (encoder license or decoder license) by operation mode. For example, operation mode [Encoderx2] requires two encoder licenses.

1.2

Components

The IP-9610 product package consists of the following components. Attachments for all series consist of same contents.

- IP-9610: 1 pc (cables separate order)



- Safety manual: 1 pc



- User's Guide: 1 pc



- Feet: 5 pcs

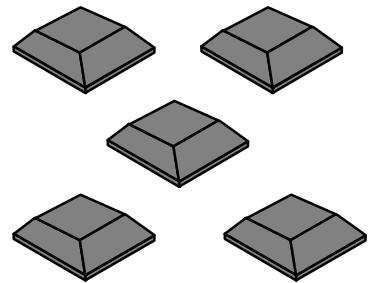

- Mounting kit on 19" rack: 2 pcs

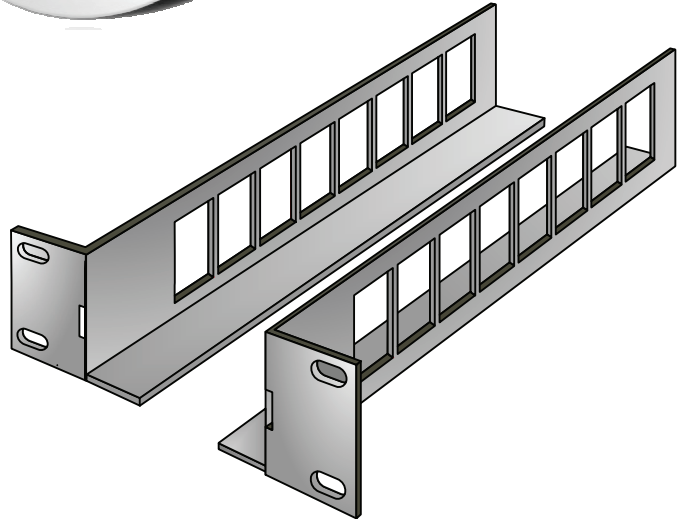
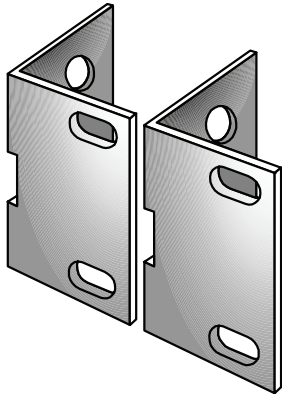

- Holder of power supply cable: 1 pc

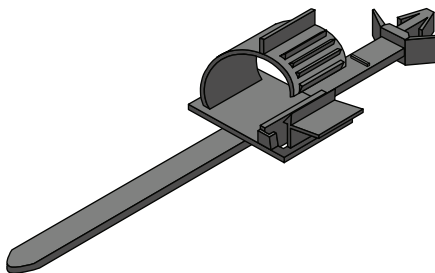

- Pan screw (M4): 6 pcs (19" rack - Mounting kit)

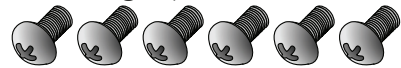

- Pan screw (M5): 8 pcs (19" rack - Mounting kit)



1.3

Basic Application Examples

Examples (system configuration) of use of IP-9610 are shown below.

The basic configuration is for video transmission via point-to-point connections.

With this configuration, the camera is connected to the encoder, and video data is transmitted to the decoder over the Internet, and then output to the monitor.

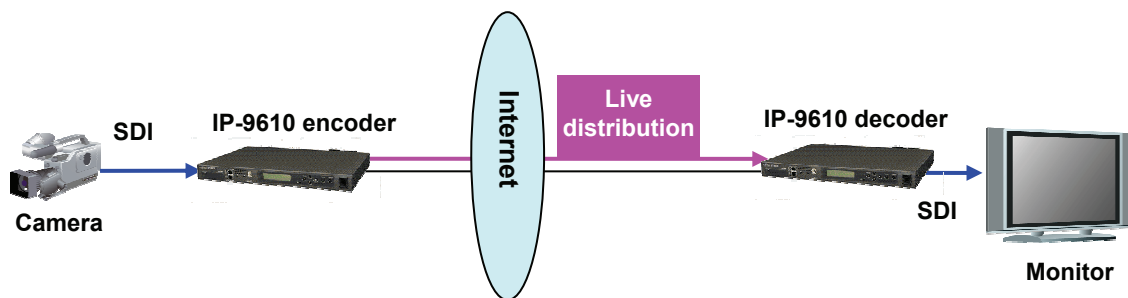

System configuration example: Broadcast content transmission or live coverage

By using the DVB-ASI interface included with this equipment as standard, the equipment can also be used for video transmission via satellite news gathering (SNG) or field pickup equipment (FPE).

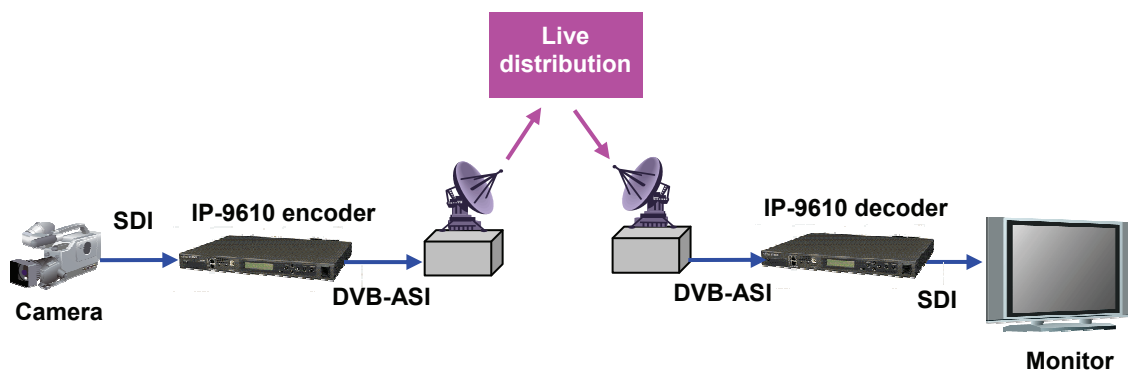

System configuration Example: SNG

1.4

Part Names

This section gives the name and describes the function of individual parts of IP-9610.

The diagrams below show the layout of parts on the outside of the device, and the table below lists the name and describes the function of individual parts. Numbers in the diagrams correspond to numbers in the table.

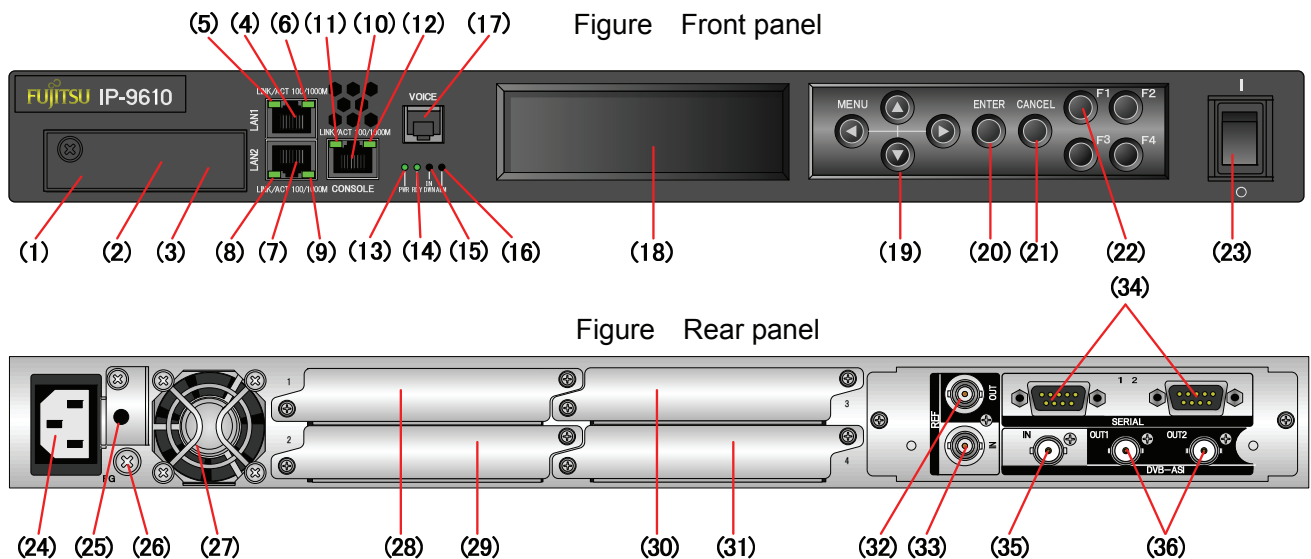

Part names

No.	Name	Description
(1)	SD CARD slot	For maintenance purpose. Not for customer. (Future Support) Covered with screw.
(2)	Maintenance port	For maintenance purpose. Not for customer..
(3)	USB port	For maintenance purpose. Not for customer. (Future Support)
(4)	LAN port #1 (LAN1)	Ethernet 10BASE-T/100BASE-TX /1000BASE-T communication port. See Section 2.6, "Connection to a Network," for an explanation on using this port. See Section 4.2, "Cable and Connector Details," for cable connection information.
(5)	Status LED (LINK/ACT)	Indicates the status of LAN port. For more information, see Table 5.3, "Details of LED Indications," in Section 5.2.
(6)	Speed LED (100/1000M)	Indicates the speed of LAN port. For more information, see Table 5.3, "Details of LED Indications," in Section 5.2.
(7)	LAN port #2 (LAN2)	Ethernet 10BASE-T/100BASE-TX /1000BASE-T communication port. See Section 2.6, "Connection to a Network," for an explanation on using this port. See Section 4.2, "Cable and Connector Details," for cable connection information.
(8)	Status LED (LINK/ACT)	Indicates the status of LAN port. For more information, see Table 5.3, "Details of LED Indications," in Section 5.2.
(9)	Speed LED (100/1000M)	Indicates the speed of LAN port. For more information, see Table 5.3, "Details of LED Indications," in Section 5.2.
(10)	CONSOLE port (CONSOLE)	Ethernet 10BASE-T/100BASE-TX /1000BASE-T communication port. See Section 2.6, "Connection to a Network," for an explanation on using this port. See Section 4.2, "Cable and Connector Details," for cable connection information.
(11)	Status LED (LINK/ACT)	Indicates the status of console port. For more information, see Table 5.3, "Details of LED Indications," in Section 5.2.
(12)	Speed LED (100/1000M)	Indicates the speed of console port. For more information, see Table 5.3, "Details of LED Indications," in Section 5.2.

No.	Names	Description
(13)	Power LED (PWR)	Turns on when the device is powered on.
(14)	Status LED (RDY)	Turn on when IP-9610 power is on. For more information, see Table 5.3, "Details of LED Indications," in Section 5.2.
(15)	AV input status LED (INDWN)	Audio/Video input setting status indicator and LED that indicates the input off status during input setting. For more information, see Table 5.3, "Details of LED Indications," in Section 5.2.
(16)	Alarm LED (ALM)	Turns on when IP-9610 operation is abnormal. For more information, see Table 5.3, "Details of LED Indications," in Section 5.2.
(17)	Voice input/output (VOICE)	Voice communication (Intercom) port between IP-9610s. See Section 2.7, "Connection to the Voice Communication (Intercom)" for an explanation on using this terminal. See Section 4.2, "Cable and Connector Details," for cable connection information.
(18)	VFD panel	Uses to set IP-9610 up and displays status. 4 lines x 24 characters.
(19)	Direction key ($\Delta \nabla \triangleleft \triangleright$)	Uses to operate IP-9610 and check the status. See Section 3.3, "Device Setting and Operation (Front Panel)" for more explanation. For more information, see Software guide.
(20)	Enter key (ENTER)	Used to finalize the displayed data on the front panel. See Section 3.3, "Device Setting and Operation (Front Panel)" for more explanation. For more information, see Software guide.
(21)	Cancel key (CANCEL)	Used to cancel the displayed data on the front panel. See Section 3.3, "Device Setting and Operation (Front Panel)" for more explanation. For more information, see Software guide.
(22)	Function key (F1 ~ F4)	Short cut key for VFD operation. Please refer "Software User's Guide" for more detail description how to use them.
(23)	Power button	Turns the device on and off.
(24)	Power inlet connector (INPUT 100-240VAC)	Can be connected to a 100-240VAC commercial power supply by using power card with a standard two-prong plug with ground. See Section 2.2.2, "Connection to a Power Source," for an explanation on using this connector. See Section 4.2, "Cable and Connector Details," for cable connection information.
(25)	AC cord clamp hole	Hole to fix AC cord clamp. See Section 2.2.2, "Power Supply System Connection" for more information.
(26)	FG terminal (FG)	Use for an FG connection to the device. See Section 2.2.1, "Connection to ground," for an explanation on using this terminal.
(27)	FAN	Maintenance-free FAN that cools the inside of the device.
(28)	Optional slot 1	The option board for external interface (video/audio) is assembled according to the system. The option board must be assembled in this slot at least.
(29)	Optional slot 2	The option board for external interface (video/audio) is assembled according to the system.
(30)	Optional slot 3	The option board for external interface (video/audio) is assembled according to the system.
(31)	Optional slot 4	The option board for external interface (video/audio) is assembled according to the system.
(32)	Reference clock signal output (REF OUT1, 2)	External clock signal output terminal. 75Ω unbalanced. See Section 2.3, "Connection to External Sync (REF)," for an explanation on using this terminal. See Section 4.2, "Cable and Connector Details," for cable connection information.

No.	Names	Description
(33)	Reference clock signal input (REF IN)	External clock signal input terminal. 75Ω unbalanced. See Section 2.3, “Connection to External Sync (REF),” for an explanation on using this terminal. See Section 4.2, “Cable and Connector Details,” for cable connection information.
(34)	RS-232C port (SERIAL)	RS-232C data communication port. See Section 2.5, “Connection to an RS-232C Device,” for an explanation on using this pin. See Section 4.2, “Cable and Connector Details,” for cable connection information.
(35)	DVB-ASI input (DVB-ASI IN)	DVB-ASI input terminal. 75Ω unbalanced. See Section 2.4, “Connection to DVB-ASI Device” , for an explanation on using this terminal. See Section 4.2, “Cable and Connector Details”, for cable connection information.
(36)	DVB-ASI output (DVB-ASI OUT1,2)	DVB-ASI output terminal. 75Ω unbalanced. See Section 2.4, “Connection to DVB-ASI Device”, for an explanation on using this terminal. See Section 4.2, “Cable and Connector Details”, for cable connection information.

(This page is intentionally left blank)

CHAPTER 2

INSTALLATION AND CONNECTION

This chapter describes conditions for IP-9610 installation and explains how to connect it to peripheral devices.

2.1	Installation Conditions	13
2.2	Power Supply System Connections	18
2.3	Connection to External Sync (REF)	22
2.4	Connection to DVB-ASI Device	23
2.5	Connection to RS-232C Device	25
2.6	Connection to Network	26
2.7	Connection to Voice Communication (Intercom)	27
2.8	Optional Board Slot	28

CAUTION

Possibility of serious injury

The power cord and other cables connected to IP-9610 may become entangled with someone walking close to them, possibly leading to serious injury and property damage. Clamp the cables to the rack or floor.

2.1

Installation Conditions

This section describes the installation environment, air flow into and out from the device, and the requirement for open space around the device.

2.1.1 Environment conditions

Ensure that installation site conditions do not exceed 50°C. Under this condition, IP-9610 can operate in the multiple piles. Otherwise, the operating environment may damage and shorten the product life of IP-9610 noticeably.

2.1.2 Installation environment

1. 19" rack mounting

Using the mounting kit, it is possible to mount on 19" rack complied EAI standard (1U size).

CAUTION

The mounting kit attached must be used to install. When the installation is unstable, the serious accident may be caused.

- (1) Check all cables disconnected.
- (2) Install the rear mounting kit on 19" rack using the four screws.

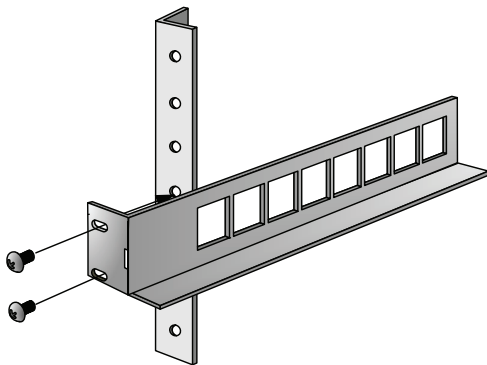

19" rack rear side

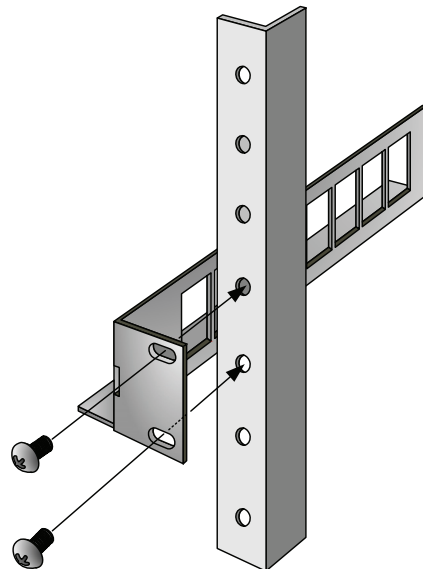

(3) Install the rack mounting kit on 19" rack using six screws.

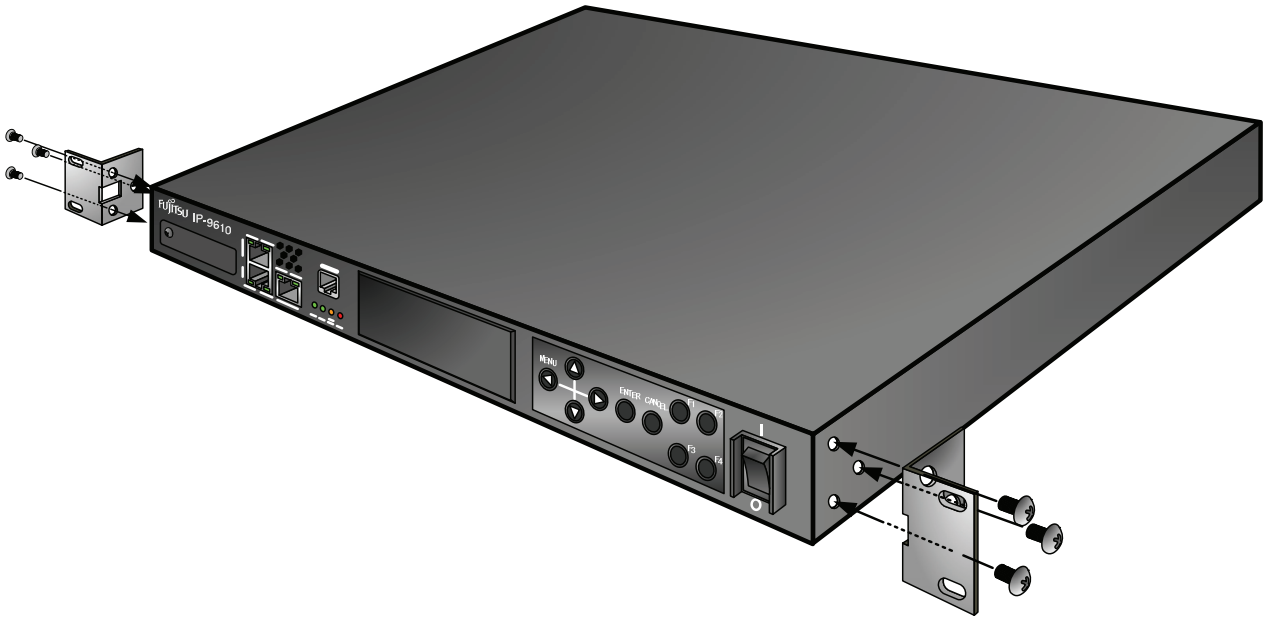

(4) Install IP-9610 on 19" rack using the four screws (M5) attached.

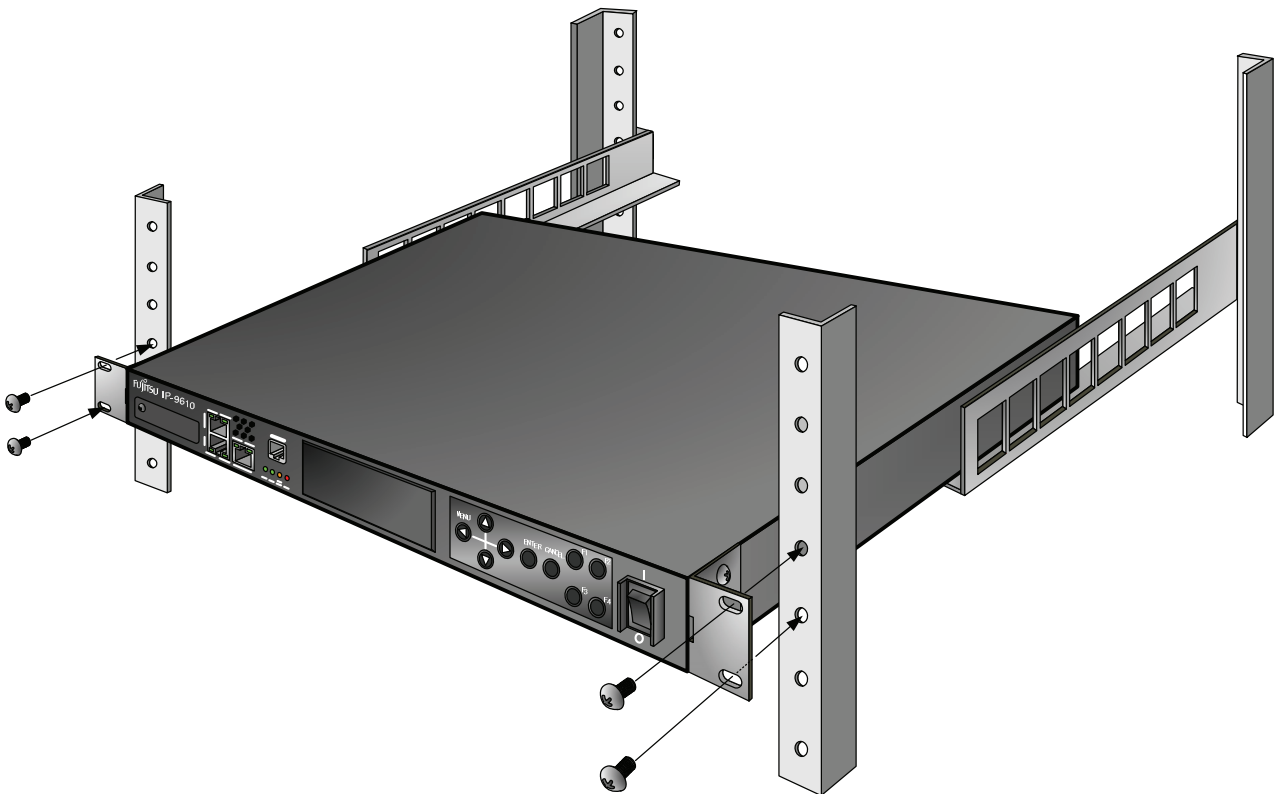

2. Desk-top installation

Install IP-9610 referring Section 2.1.3, “Air flow into and out from the device” and Section 2.1.4, “Open space required around the device” after sticking the five rubber feet (Rack mounting kit is not required).

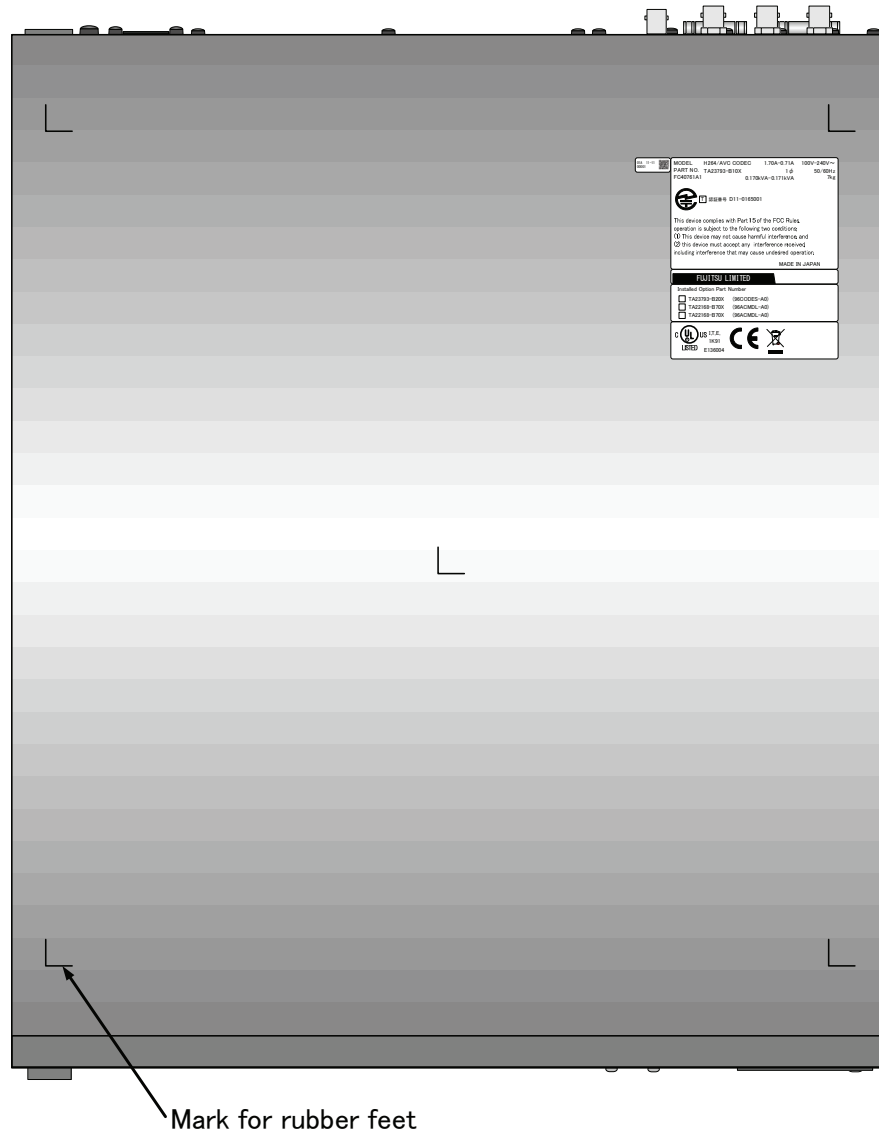

CAUTION

Safety installation instruction:

1) Multiple pile

The maximum 5 IP-9610 can be piled under the environment condition specified. Please install considering the maintenance-ability. When IP-9610 are piled, please fix them to avoid to fall (Do not cover the air intake.). See Section 2.1.4, “Open space required around the device” for the installation space.

2) rack mounting

- a) When IP-9610 is installed in a closed or multi-unit rack, the operating ambient temperature inside of the rack environment may be greater than room ambient. Therefore, the consideration should be given to operate in the environment compatible with the specifications in Appendix 2.2 “Environment Specifications.”
- The consideration for adjustment of the air condition like air circulation should be given to prevent the internal rack ambient from exceeding the maximum operating ambient temperature of IP-9610.
 - The maximum operating ambient temperature for IP-9610: 50°C.
- b) The installation of IP-9610 in a rack should be such that the amount of airflow required for safe operation of IP-9610 is not compromised.
- IP-9610 has ventilation opening at the left and rear side.
 - Do not cover or close these ventilation openings to prevent overheating.
- c) The mounting of IP-9610 in a rack should be such that a hazardous condition is not archived due to uneven mechanical loading. To keep stability of the entire rack, please fix the rack to wall or floor by suitable means.
- Be careful about injury during installation of IP-9610 into rack.
 - Do not install IP-9610 into your rack where IP-9610 may make the entire rack unstable.
 - The weight of IP-9610 with the maximum configuration: 7 kg
- d) If IP-9610 is supplied from the power strip or the service outlet of other units, it may overload the power supply cord of the power strip or other units.
- Confirm that the current rating of the power strip or the service outlet exceeds the combined ratings of all equipment is supplying.
 - The electrical rating of IP-9610: Rated 100-240 VAC, 1.70-0.71 A, 50/60 Hz, 1 phase.
- e) The reliable earthing of the rack-mounted equipment must be maintained. The particular attention should be given to supply connections other than direct connections to the branch circuit (e.g., use of the power strips or the power distribution unit).
- Note:** The high leakage current may flow through the power strip earthing conductor if all power supply cords of IP-9610 are connected to one power strip. The earth connection is essential before connecting supply. If the power strip is not directly connected to the branch circuit, the power strip which has the industrial type attachment plug should be used.

2.1.3 Air flow into and out from the device

IP-9610 is forced air cooled. Be sure not to block the air intake/exhaust vents. Provide an adequate amount of space around the vents.

2.1.4 Open space required around the device

Provide the indicated (parts with hatched area) below, cable forming space, operation space and air intake/exhaust.

For the information of maintenance space, see Section 5.3.1, “Maintenance space.”

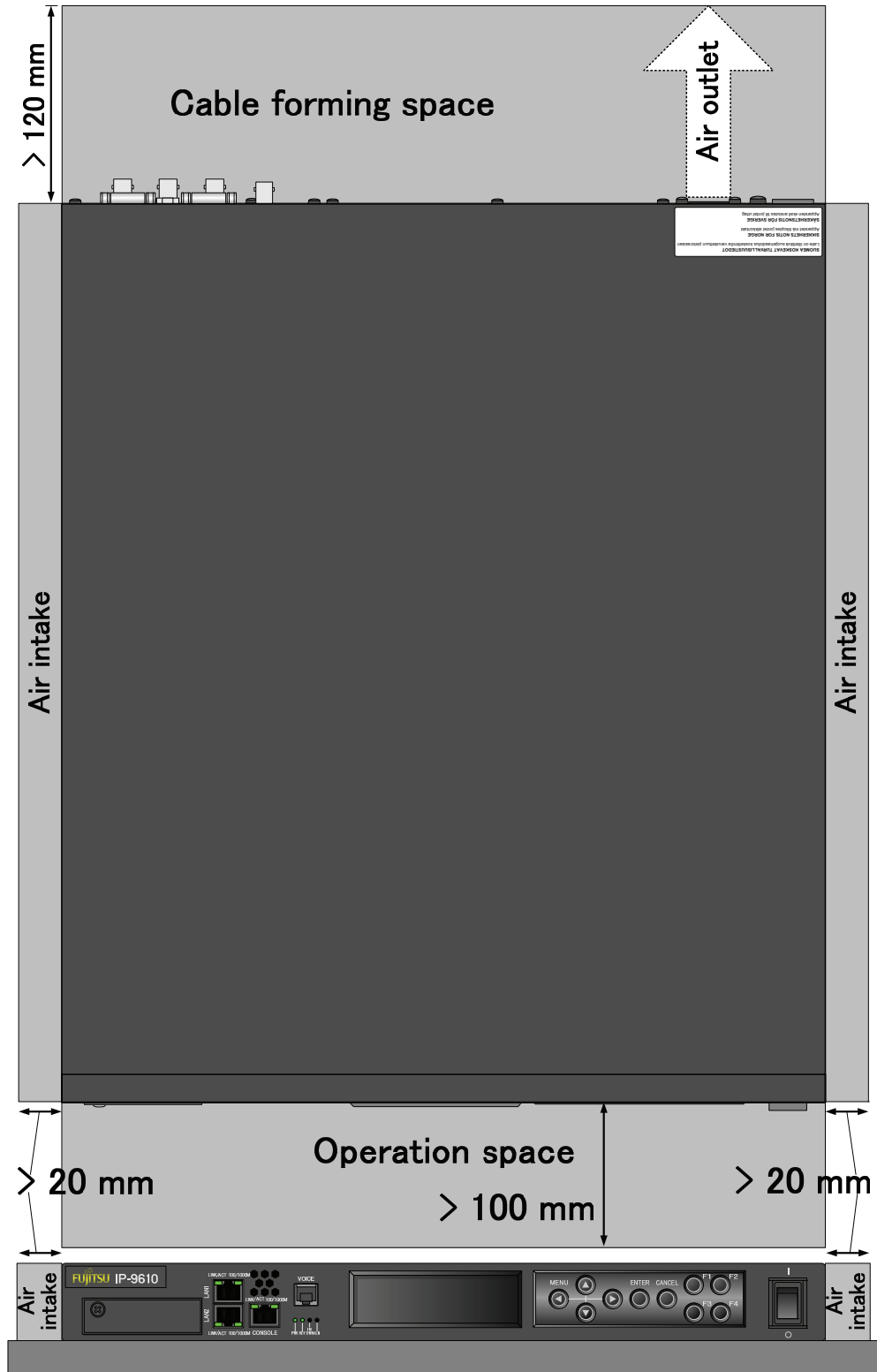

2.2

Power Supply System Connections

This section explains ground and power-source connections.

2.2.1 Connection to ground

Use a power cord with the standard two-prong plug with ground wire for FG and external ground connections.

When the exogenous noise influences IP-9610, connect the FG terminal to an external ground.



FG terminal (M4)

2.2.2 Connection to power source

IP-9610 operation requires a power supply of 100-240 VAC. Insert the power cord with the standard two-prong plug with ground into the inlet connector.

The power cord is not supplied with the device. Please procure it separately.

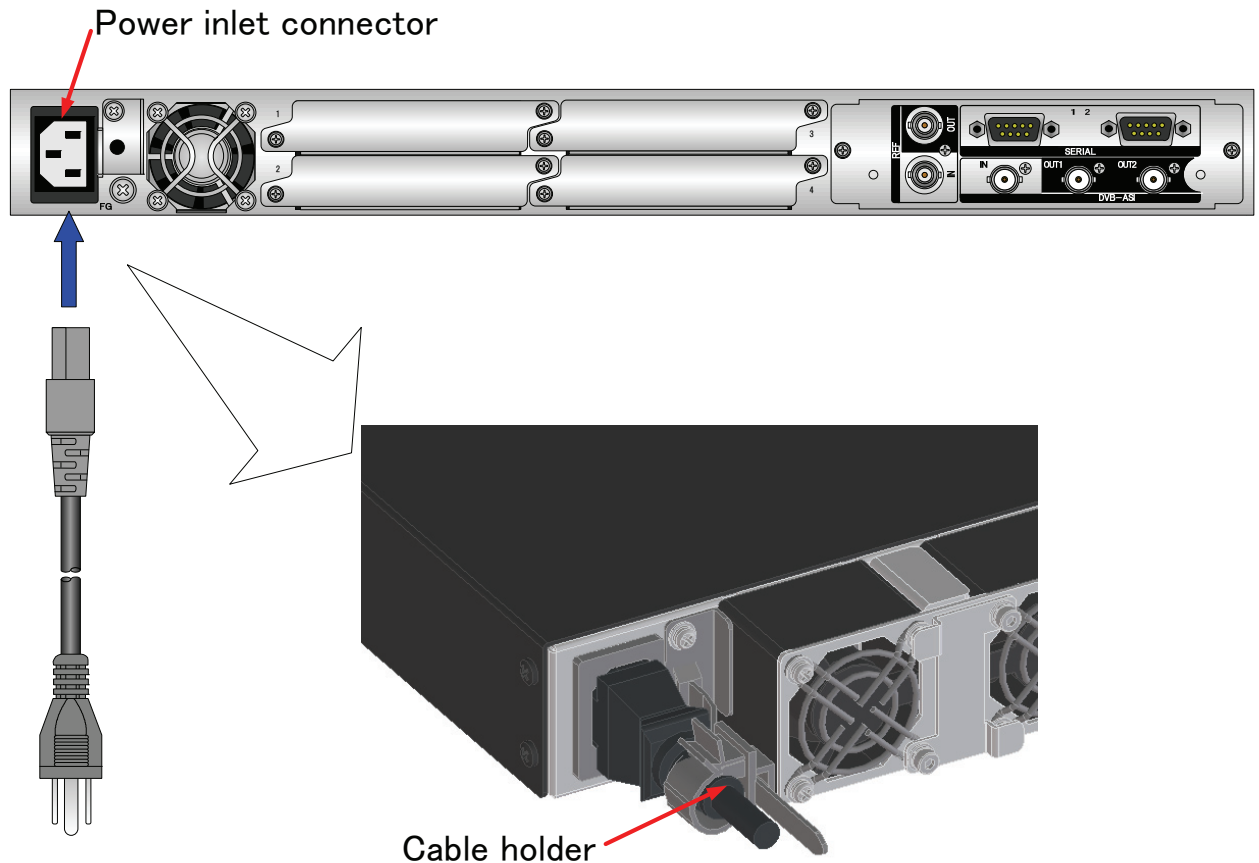





















Figure Power cord connection

AC cable clamp











Insert the AC cable clamp into the AC cable clamp hole and fix the power cord as shown in figure above. When remove the AC cable clamp, screw out and remove it with the mounting kit.

USABLE DETACHABLE POWER SUPPLY CABLE SET

MODEL	Input	Connector	Cord	Attachment Plug cap
North America <*1> <*2>	100-120V	IEC C-13 Rated 13A, 125V UL, CSA Approved 	Type SJT, No.16 AWG Min. 3-Conductors (Single phase;2-current carrying conductors & ground) UL, CSA Approved	NEMA (5-15P) parallel blade Rated 13A, 125V UL, CSA Approved 
	200-240V	IEC C-13 Rated 15A, 250V UL, CSA Approved 	Type SJT, No.14 AWG Min. 3-Conductors (Single phase; 2-current carrying conductors & ground) UL, CSA Approved	NEMA (6-15P) tandem blade Rated 15 A, 250 V UL, CSA Approved 
Europe <*2>	100-240V	IEC C-13 Rated 10A, 250V <*1>	CENELEC OC 3X1.0 square mm<*1> <HAR>	Rated 10 A, 250 V <*1>
Australia	100-240V	IEC C-13 Rated 10A, 250V 	Cable: AS OD 3 X1.0 square mm e.g. 	Rated 10 A, 250 V 
U.K <*2>	100-240V	IEC C-13 Rated 10A, 250V 	BS OC 3 X1.00 square mm	Rated 10 A. 250 V  or 
Japan	100V	IEC C-13 Rated 13A, 125V	Type HVCTF cross section area 1.25 square mm 3-Conductors (Single phase;2-current carrying conductors & ground)	NEMA (5-15P) parallel blade Rated 13 A, 125 V
		METI Approved  or <PSE>	METI Approved  or <PSE>	METI Approved  or <PSE>
Korea	220V (Class I)	IEC 60320-1 (IEC C-13) Rated 12A, 250V 	Comply with KSC3304. Type VCTF cross section area 1.25 (0.50 or 1.00 or 2.00) square mm 3-Conductors (Single phase;2-current carrying conductors & ground) 	Comply with KSC8305. Rated 12A, 250V 
	220V (Class II)	IEC 60320-1 (IEC C-13) Rated 3A, 250V 	Comply with KSC3304. Type VCTFK cross section area 1.25 (0.50 or 0.75 or 1.00 or 2.00) square mm 2-Conductors 	Comply with KSC8305. Rated 12A, 250V 

Note: *1. Be sure that the detachable proper Supply cord has the approval of the appropriate safety agencies of the country where the equipment will be used.
*2. Cable length of above Power Supply cord shall be shorter than 4.5 m.

CERTIFICATION MARKING

Country	Agency	Certification Mark	Country	Agency	Certification Mark
Austria	OVE		Italy	IMQ	
Belgium	CEBEC		Norway	NEMKO	
Denmark	DEMKO		Spain	AEE	
Finland	FEI		Sweden	SEMKO	
France	UTE		Switzerland	SEV	
Germany	VDE				

⚠ WARNING**Possibility of electric shock, fire, and damage to the device**

Always observe the precautions given below.

This indicates a hazardous situation that could lead to electric shock, fire, or damage to the device.

Always connect the power cord to a power receptacle for the standard two-prong plug with ground.

Use a power receptacle with a capacity of 1A or more. When using a power extension cable, be sure that the total power consumption of all devices connected to the cable does not exceed the rated capacity of the cable. If the power receptacle capacity is low, or power consumption exceeds the rated value, the power cord or power wiring may overheat and start a fire.

⚠ CAUTION**Possibility of damage to the device**

Do not turn on the device until connection of peripheral devices is completed. Otherwise, the device may be damaged.

100-240 VAC

Using a power cord with the standard two-prong plug with ground, connect IP-9610 to 100-240 VAC outlet.

Provide a power receptacle for the standard two-prong plug with ground.

2.3

Connection to External Sync(REF)

There is each of input and output interfaces for connection to the external sync (REF).

REF input

Connect incoming external sync to REF IN by using coaxial cable with BNC connector. The signal is terminated in 75 ohm.

REF OUT

Connect coaxial cable with BNC connector to REF OUT for outgoing external sync signal. The signal is output in 75 ohm.

NOTE: For details about connectors and cables, see Section 4.2, “Cable and Connector Details.” For electrical specifications, see Appendix 2.3, “Function Specifications.”

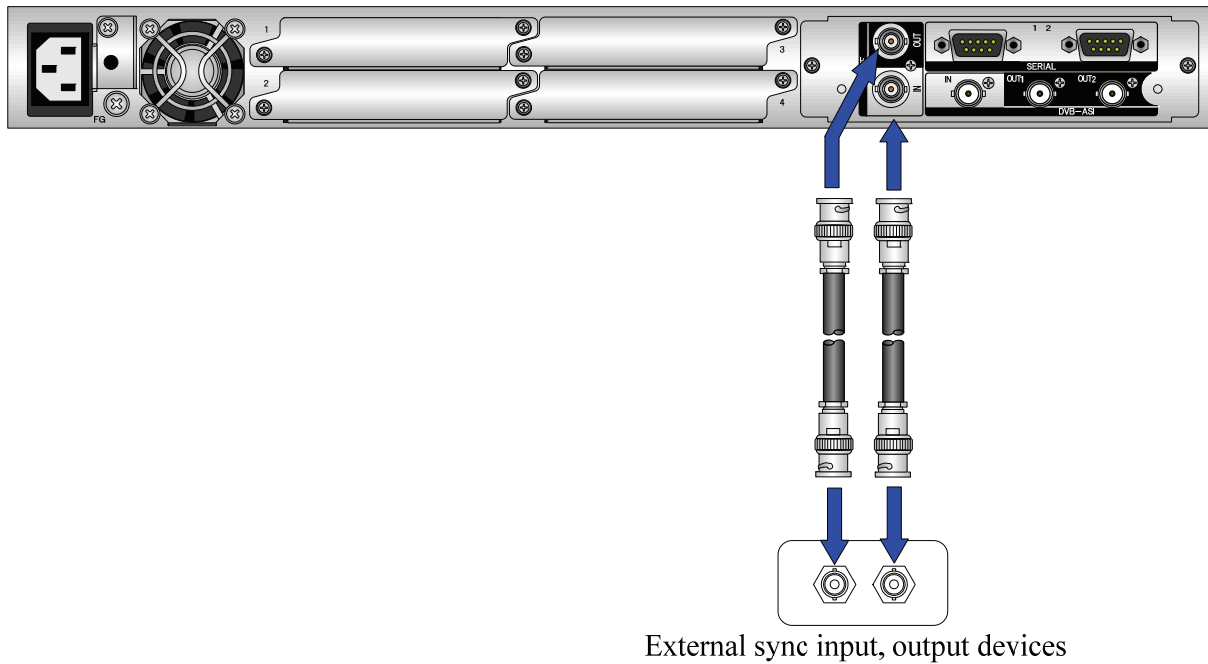

Figure Connection to External Sync input, output devices

2.4

Connection to DVB-ASI Device

This section describes how to connect with the DVB-ASI device.

2.4.1 Connection to DVB-ASI Input Device

When IP-9610 operates with the encoder mode, the BNC cable is connected to DVB-ASI OUT as shown in the figure below.

NOTE: For details about connectors and cables, see Section 4.2, “Cable and Connector Details.”
For electrical specifications, see Appendix 2.3, “Function Specifications.”

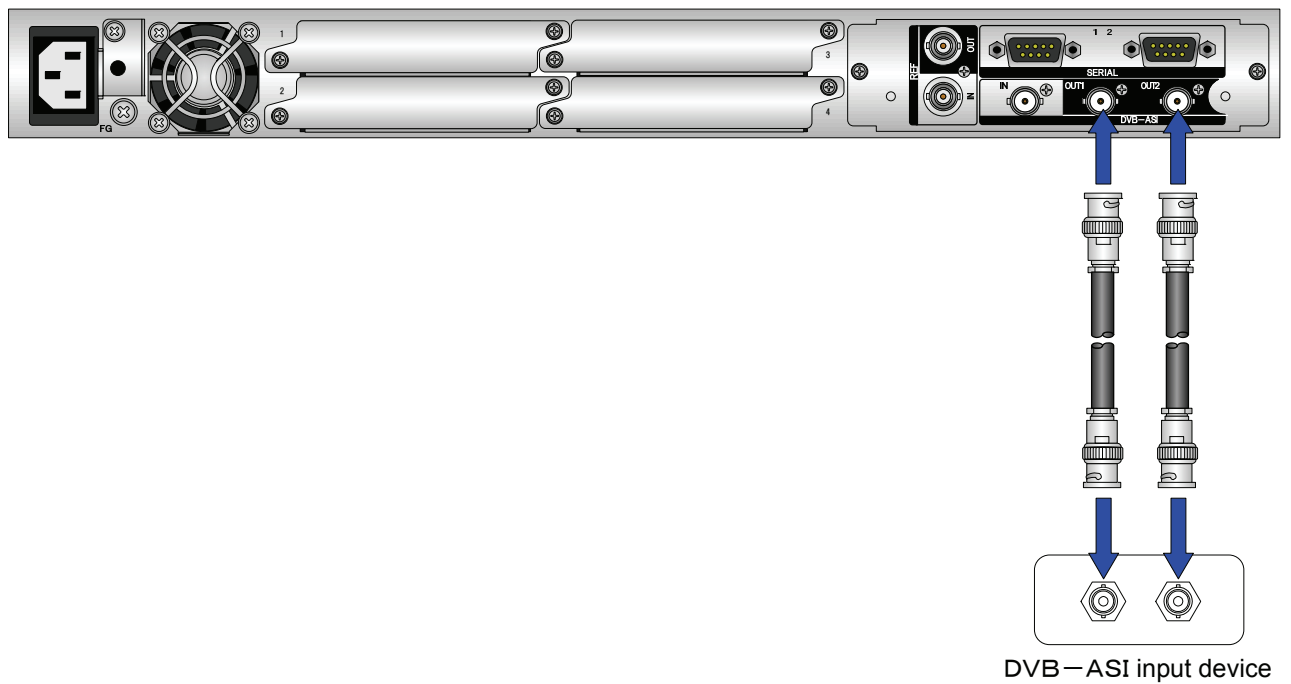

Figure Connection to DVB-ASI input device

2.4.2 Connection to DVB-ASI Output Device

When IP-9610 operates with the decoder mode operates, the BNC cable is connected to DVB-ASI IN as shown in the figure below. The signal is terminated in 75Ω.

NOTE: For details about connectors and cables, see Section 4.2, “Cable and Connector Details.”
For electrical specifications, see Appendix 2.3, “Function Specifications.”

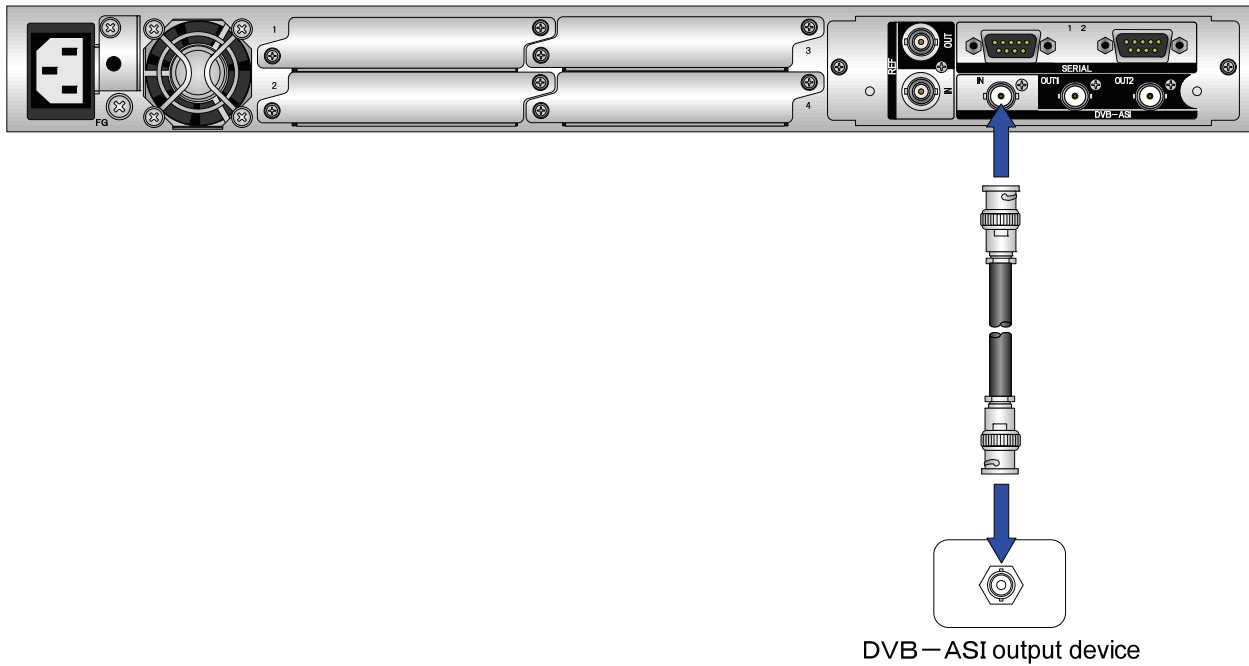

Figure Connection to DVB-ASI output device

2.5

Connection to RS-232C/RS-422 Device

The [SERIAL] connector of IP-9610 is the RS-232C or RS-422 communication terminal (switchable). The terminal of IP-9610 is the D-sub 9 pins (male). The specification of RS-232C operating mode is DTE. Use a cross connection or straight cable corresponding to the connected device. See Section 4.2, "Cable and Connector Details."

The figure below shows the connection method.

NOTE: For details about connectors and cables, see Section 4.2, "Cable and Connector Details." For electrical specifications, see Appendix 2.3, "Function Specifications."

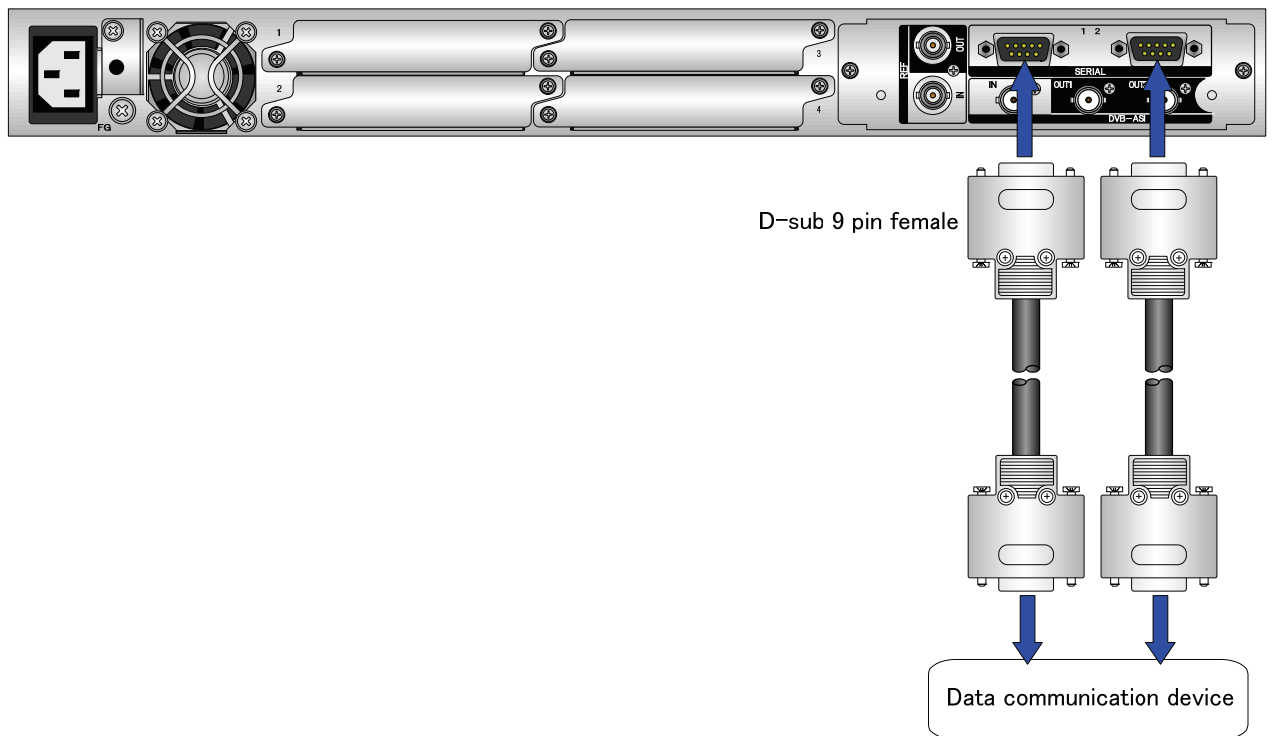

Figure Connection to RS-232C or RS-422 input/output device

2.6

Connection to Network

To connect IP-9610 to a LAN device, connect the LAN device to the LAN communication port [CONSOLE/LAN1/LAN2] of IP-9610 using a LAN cable (UTP cable). The LAN communication port specification of IP-9610 is 10BASE-T/100BASE-TX /1000BASE-T for CONSOLE, LAN1 and LAN2.

The figure below shows the connection method.

NOTE: For details about connectors and cables, see Section 4.2, “Cable and Connector Details.”
For electrical specifications, see Appendix 2.3, “Function Specifications.”

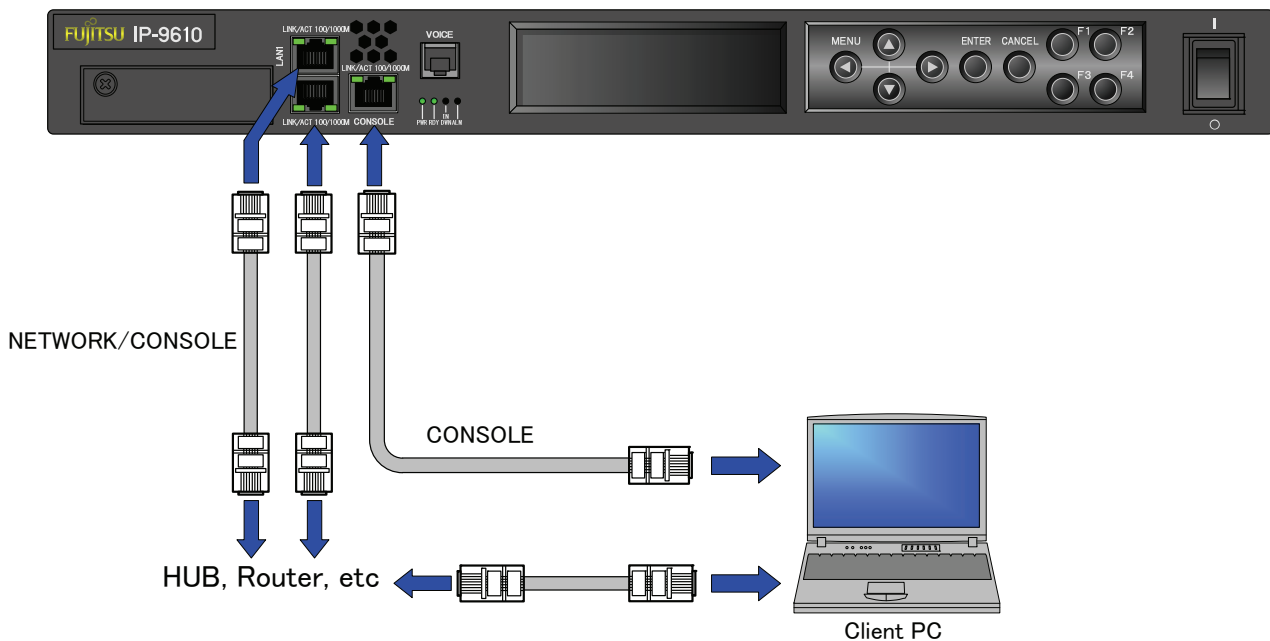

Figure Connection to network

⚠ CAUTION

Please do not provision the IP address below.

LAN/Console ports;

- IP address commonly unused (0.0.0.0, 255.255.255.255, etc...)
- Loop back address (127.xxx.xxx.xxx)
- Class D and Class E addresses
- IP address already used

Console port only;

- IP address (169.254.xxx.xxx) used when LAN port cannot obtain IP address normally from DHCP server.

For more information, see IP-9610 Software User's Guide.

2.7

Connection to Voice Communication (Intercom)

Connection to the Voice Communication (Intercom)

For voice communication between IP-9610, there is one voice terminal to connect the voice communication device (e.g., intercom).

Connect to VOICE terminal on the front panel of IP-9610 using the dedicated adaptor cable with the bidirectional voice communication terminal (RJ25 – XLR). The impedance is terminated in 600Ω. There are two types of the cables. Procure the appropriate type separately because this cable is not attached to IP-9610. For more information, see Section 4.2, "Cable and Connector Details."

NOTE: For details about connectors and cables, see Section 4.2, "Cable and Connector Details." For electrical specifications, see Appendix 2.3, "Function Specifications."

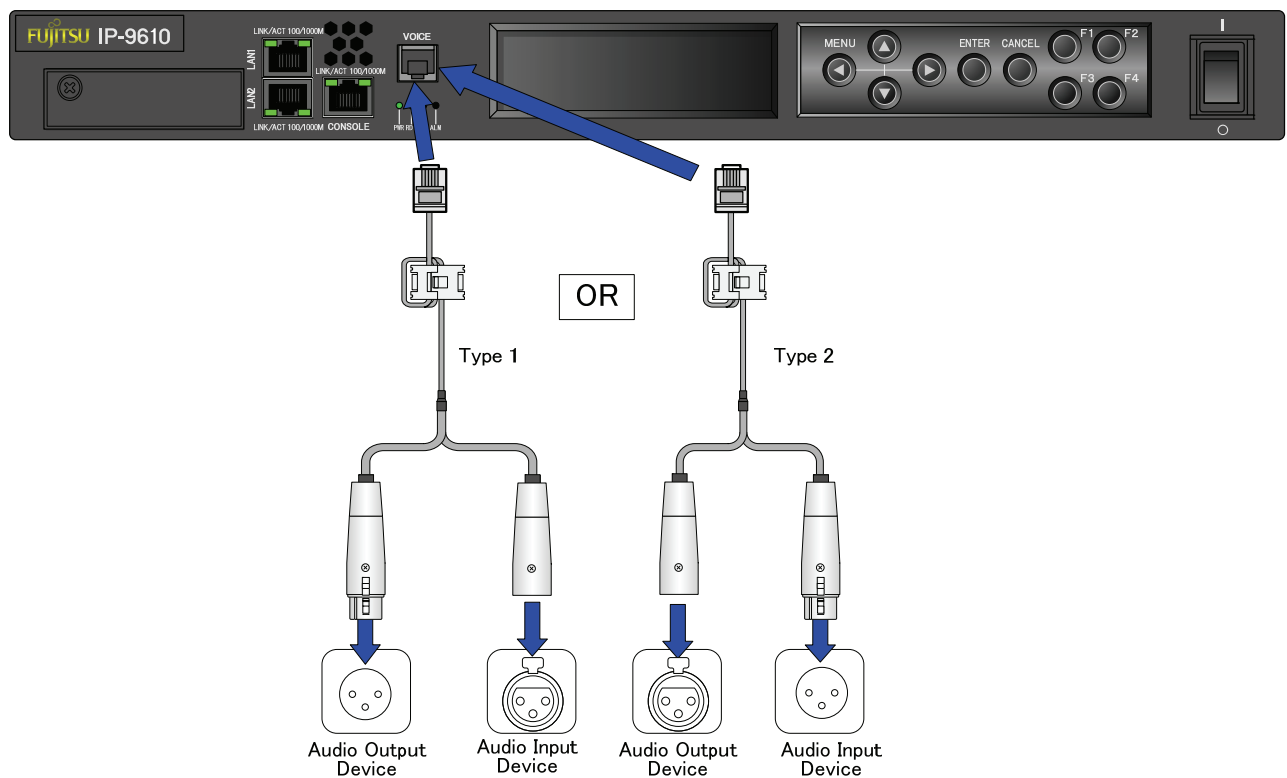

Figure Connection to voice communication device

2.8

Optional Board Slot

IP-9610 provides 4 option slots.

The external interface option board must be assembled in slot #1 at least.

The option board for external interface (video/audio) in each slot of #2~#4 is assembled according to the system configuration.

Please confirm to an empty slot of an optional slot the installation of the blank board without fail.

The install procedure of optional board is as follows.

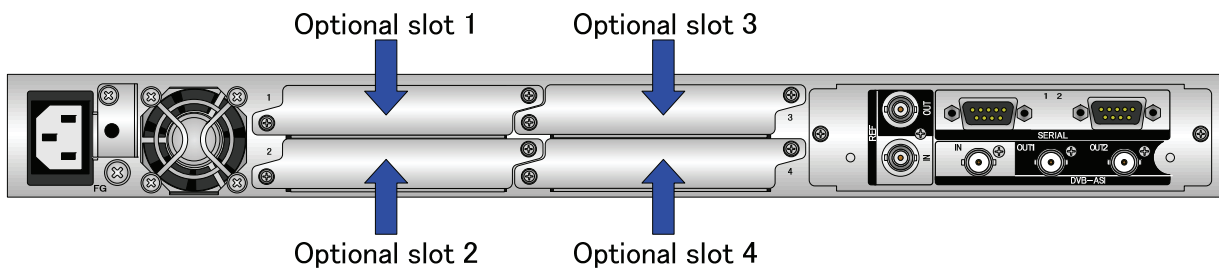

WARNING

Please turn off the power of IP-9610 when the optional board is inserted or removed. Otherwise, it may cause the serious damage to the device or injury.

- ① Loosen a attachment screw of the slot to load. The attachment screw is to prevent dropping off.

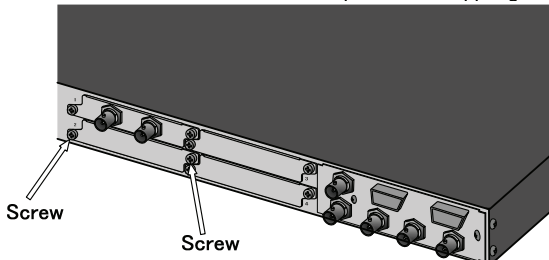

- ③ Insert interface option board into IP-9610 chassis along chassis' guide rail.

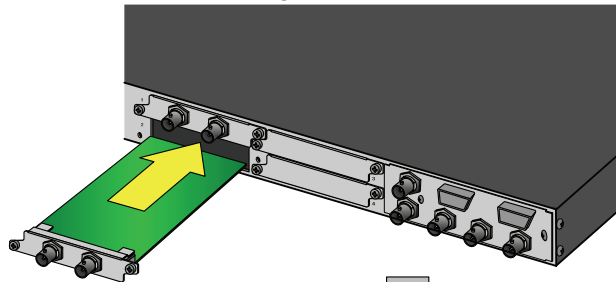

- ② Pinch the loosened attachment screw and remove blank panel or optional card from the option slot.

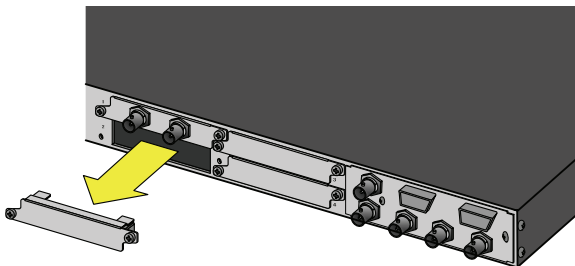

- ④ Screw in to fix the card.

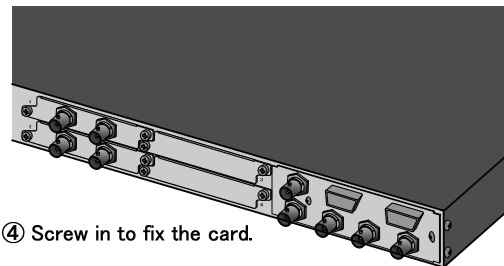

- ⑤ To remove this card, follow the procedure from ④ to ①.

CHAPTER 3

OPERATION INSTRUCTIONS

This section explains how to power on/off, setup and operate the device.

3.1	Power ON/OFF	31
3.2	Device Settings and Operation	32
3.3	Device Setting and Operation (Front Panel)	33
3.4	Special Use of Cancel Key	34

(This page is intentionally left blank)

3.1

Power ON/OFF

This section explains how to power on/off the IP-9610.

3.1.1 Powering on

When the power button on the front panel is set to the [|] position, the PWR LED turns on.

When IP-9610 completes preparations for operation, the RDY LED turns on.

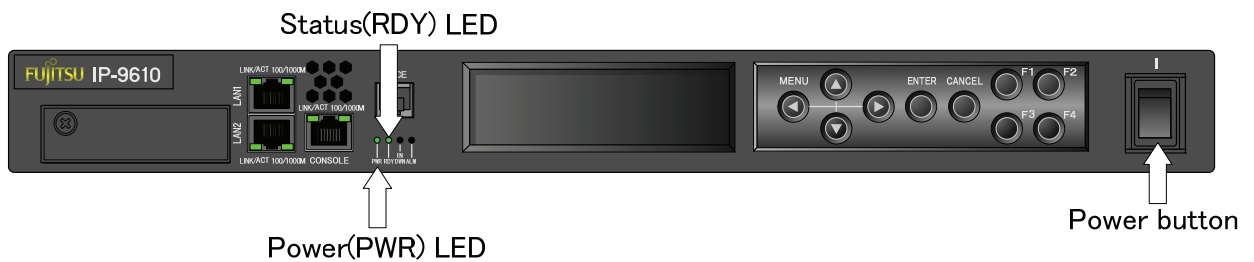

3.1.2 Powering off

When the power button on the rear panel is set to the [O] position, the device is powered off and the PWR LED turns off.

3.2

Device Settings and Operation

■Setup Procedure

The setup procedure is shown below.

See Software User’s Guide for the procedure of the software installation and the each setting.

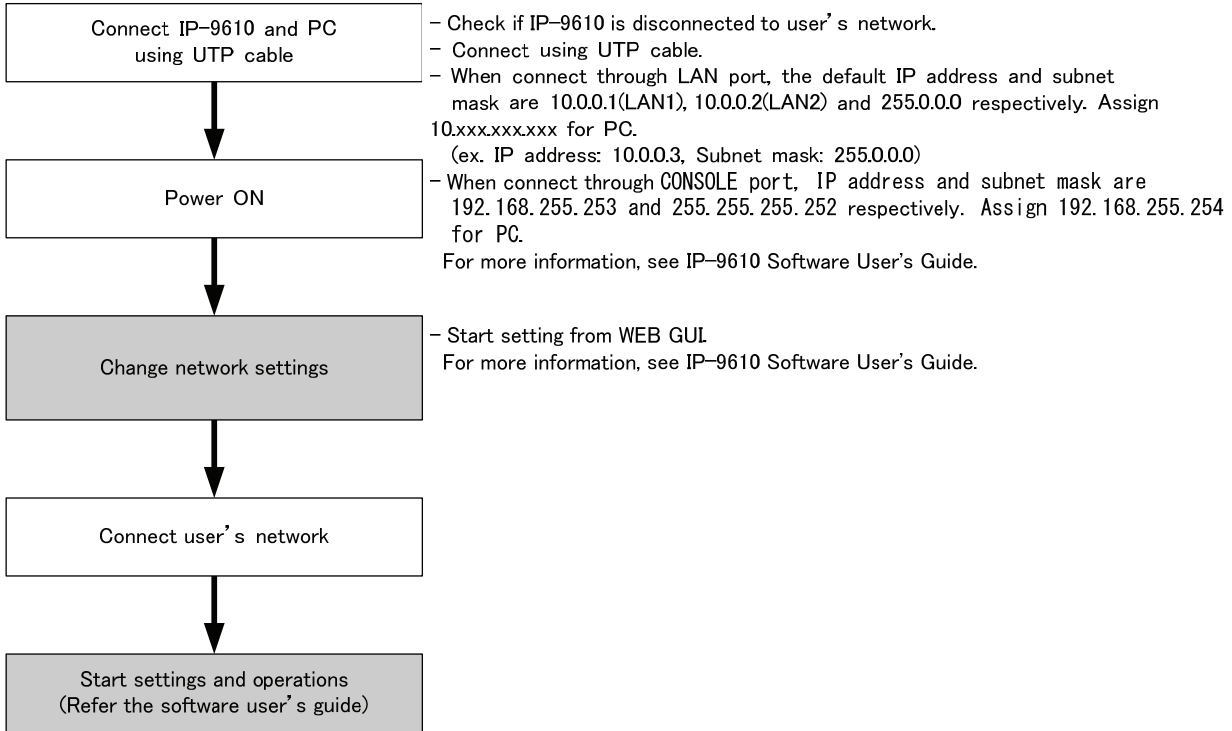

■Web browser recommended

The supported Web browsers are Internet Explorer, Safari, and Firefox.

Browsers whose operation has been confirmed: Internet Explorer 8, 9

Safari 5

Firefox 5

3.3

Device Settings and Operation (Front Panel)

The IP-9610 has six control keys: [Δ], [∇], [\triangleleft], [\triangleright], [Enter], [Cancel], [F1], [F2], [F3] and [F4]. Use these keys for making settings.

The VFD panel displays of 4 lines, 24 characters per line.

See Software User's Guide for the procedure of the software installation and the each setting.

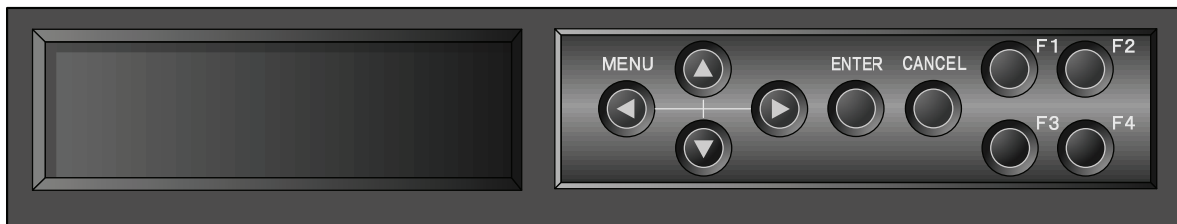

Front Control Panel

■Function description of each key

Functions of [Δ] and [∇] keys

- Each key changes the menu items or setting items displayed on the VFD panel.
- The displayed item changes each time either key is pressed. [Δ] and [∇] change items in the opposite direction.

Functions of [\triangleleft] and [\triangleright] keys

- Each key moves the cursor displayed on the VFD panel to the left or right.
- The cursor moves one column each time either key is pressed.

[Enter] key

- Pressing the [Enter] key while the maintenance initial page is displayed proceeds to the maintenance menu page.
- Pressing the [Enter] key on the maintenance menu page allows you to make settings for status display and shutdown.

[Cancel] key

- Pressing the [Cancel] key while the maintenance menu page is displayed proceeds to the maintenance initial page. Pressing the [Cancel] key on the setting item selection page returns to the page displayed immediately before you pressed the [Enter] key.

[F1]~[F4] key

- Short cut key to any menu location. By pressing the [F1]~[F4] key, menu location can be changed to registered location. By pressing the [F1]~[F4] key for a while under the menu location that customer want to register, that menu location will be registered.

Other

- If you do not make any key input for 60 seconds on any page, the current page proceeds to the maintenance initial page.

3.4

Special Use of Cancel Key

You can start IP-9610 by turning on the power while holding down the [CANCEL] key (for about 10 seconds) until the RDY LED begins blinking in orange. Doing so starts the IP-9610 with the initial IP address and subnet mask with which the IP-9610 is shipped from the factory (CONSOLE: IP address 192.168.255.253, Subnet mask 255.255.255.252, LAN1: IP address 10.0.0.1, LAN2: IP address 10.0.0.2, Subnet mask: 255.0.0.0).

Use this function when making initial settings for IP-9610 from a control terminal (such as a PC having a LAN interface) (*1).

- *1 When you operate the IP-9610 with the default IP address, connect the device to a control terminal and make setting from the terminal with the device disconnected from your network.

After making settings according to the requirements for your network, connect the device to the network. If the device with the default settings made at the factory is connected to the network, an unexpected problem may occur with your network.

If you start IP-9610 while holding the [CANCEL] key, set the IP addresses and subnet masks of the control terminal to connect as follows:

- IP address on CONSOLE : 192.168.255.254
- Subnet mask on CONSOLE : 255.255.255.252
- IP address on LAN : 10.xxx.xxx.xxx

(xxx is any number from 0 to 255, excluding 10.0.0.0, 10.0.0.1, 10.0.0.2 and 10.255.255.255.)

- Subnet mask on LAN : 255.0.0.0

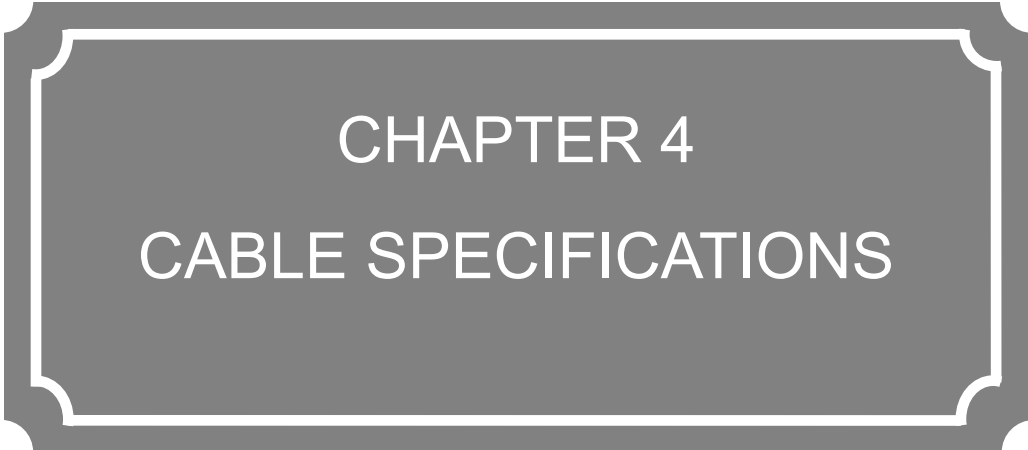

CHAPTER 4

CABLE SPECIFICATIONS

This chapter contains a type of how work is implemented, cable connection system diagrams, and cable connector details

- 4.1 Installation Preparations 37
- 4.2 Cable and Connector Details 38

(This page is intentionally left blank)

4.1

Installation Preparations

A type of IP-9610 installation work is shown below.

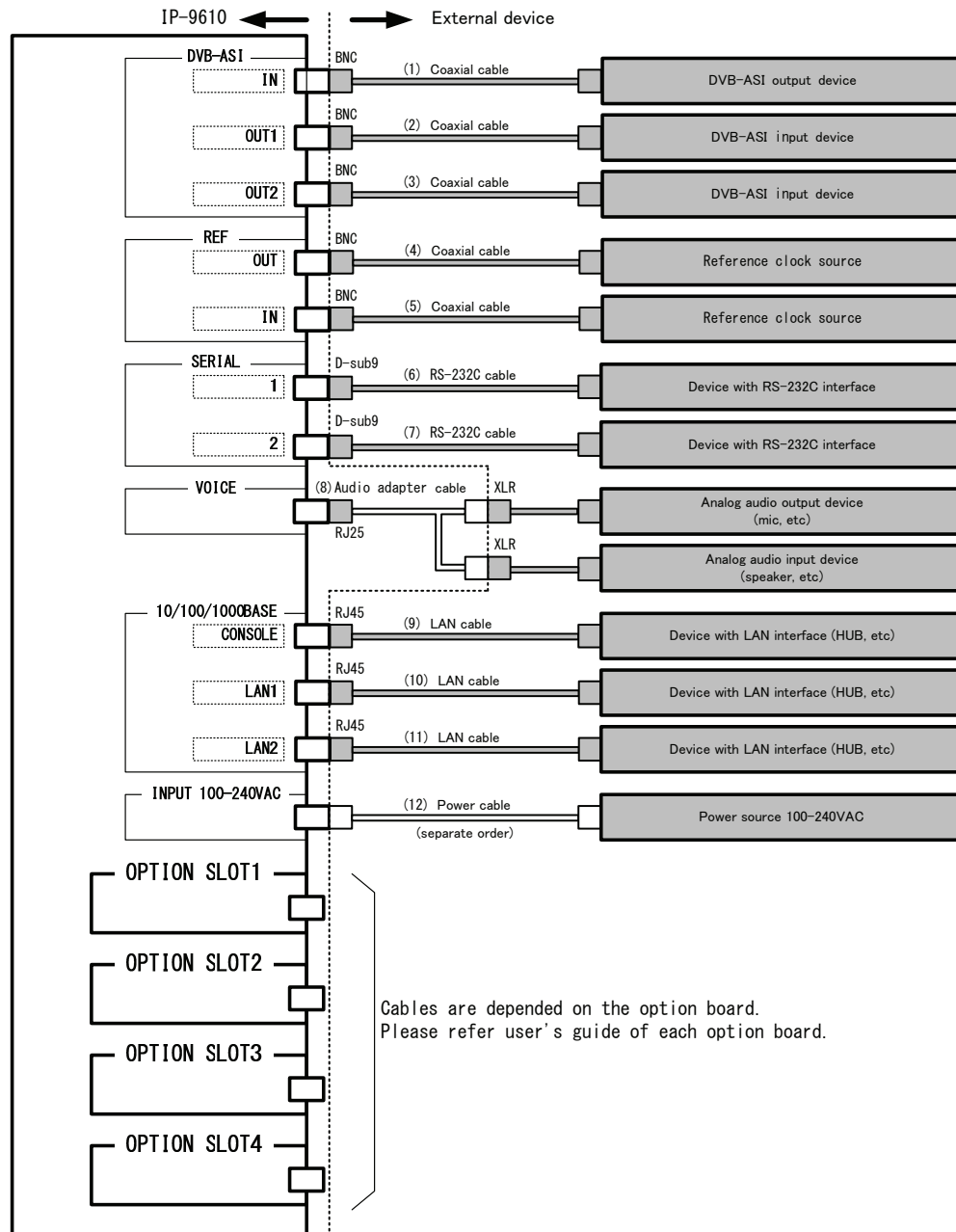

When constructing a system that uses IP-9610, consideration must be given so that its boundary between IP-9610 and other devices is similar to that shown in the above figure. Since the type of work may change depending on the system, procure equipment and perform work based on consultations with a system designer.

4.2

Cable and Connector Details

(1) DVB-ASI cable

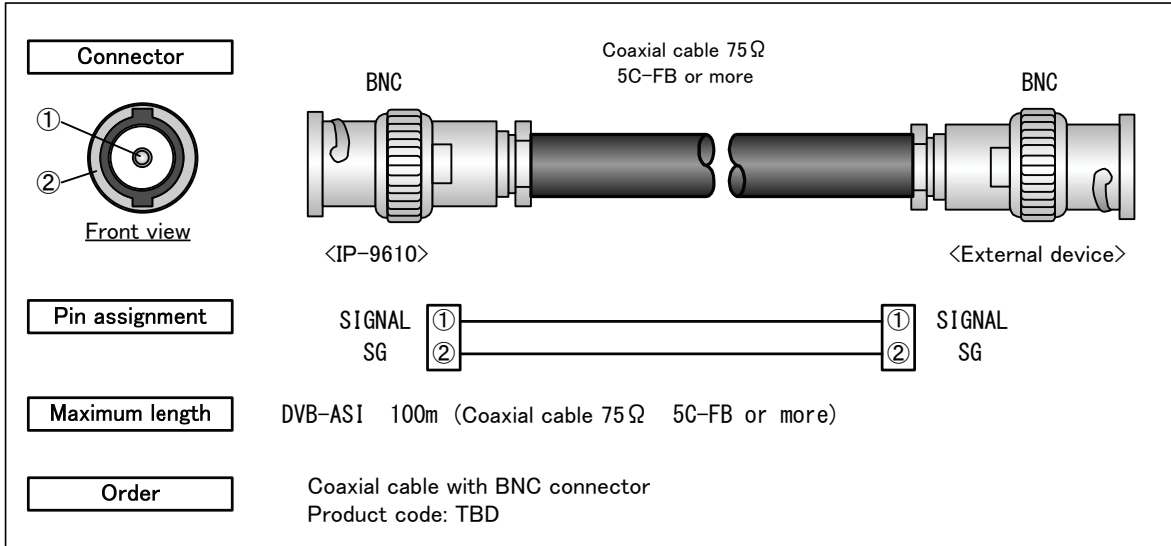

(2) External Sync(REF) cable

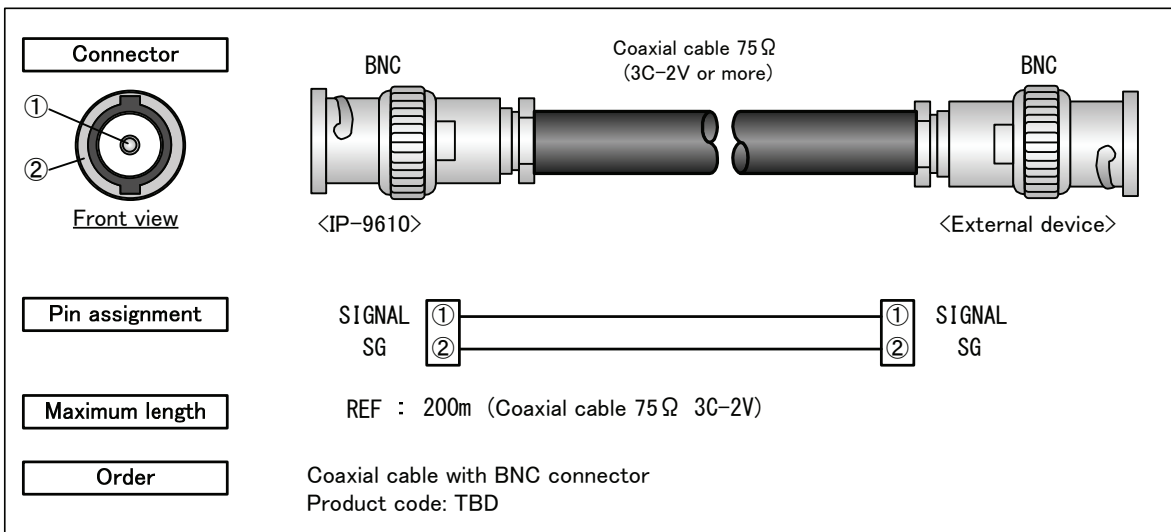

(3) RS-232C / RS-422 cable

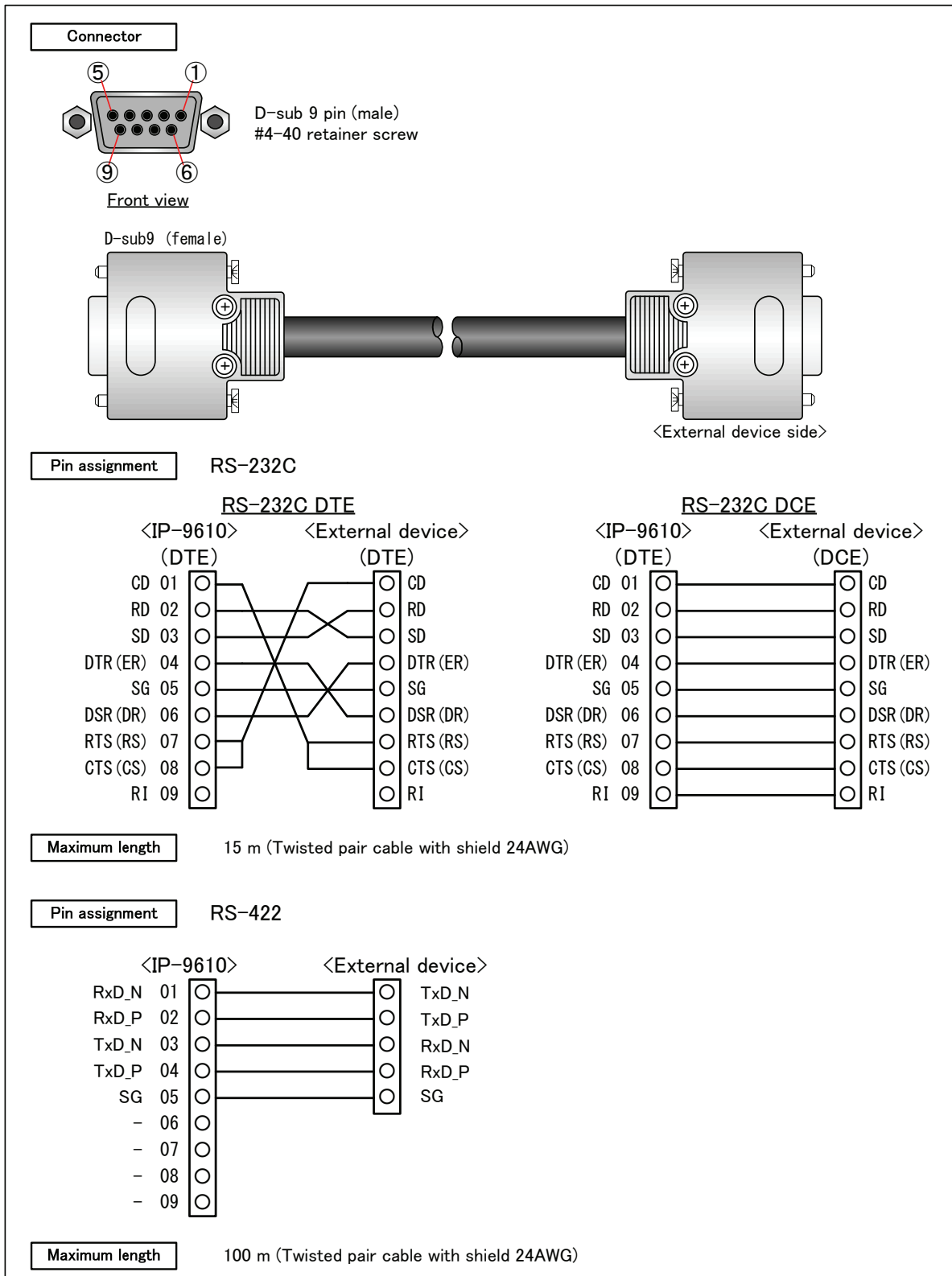

(4) LAN cable

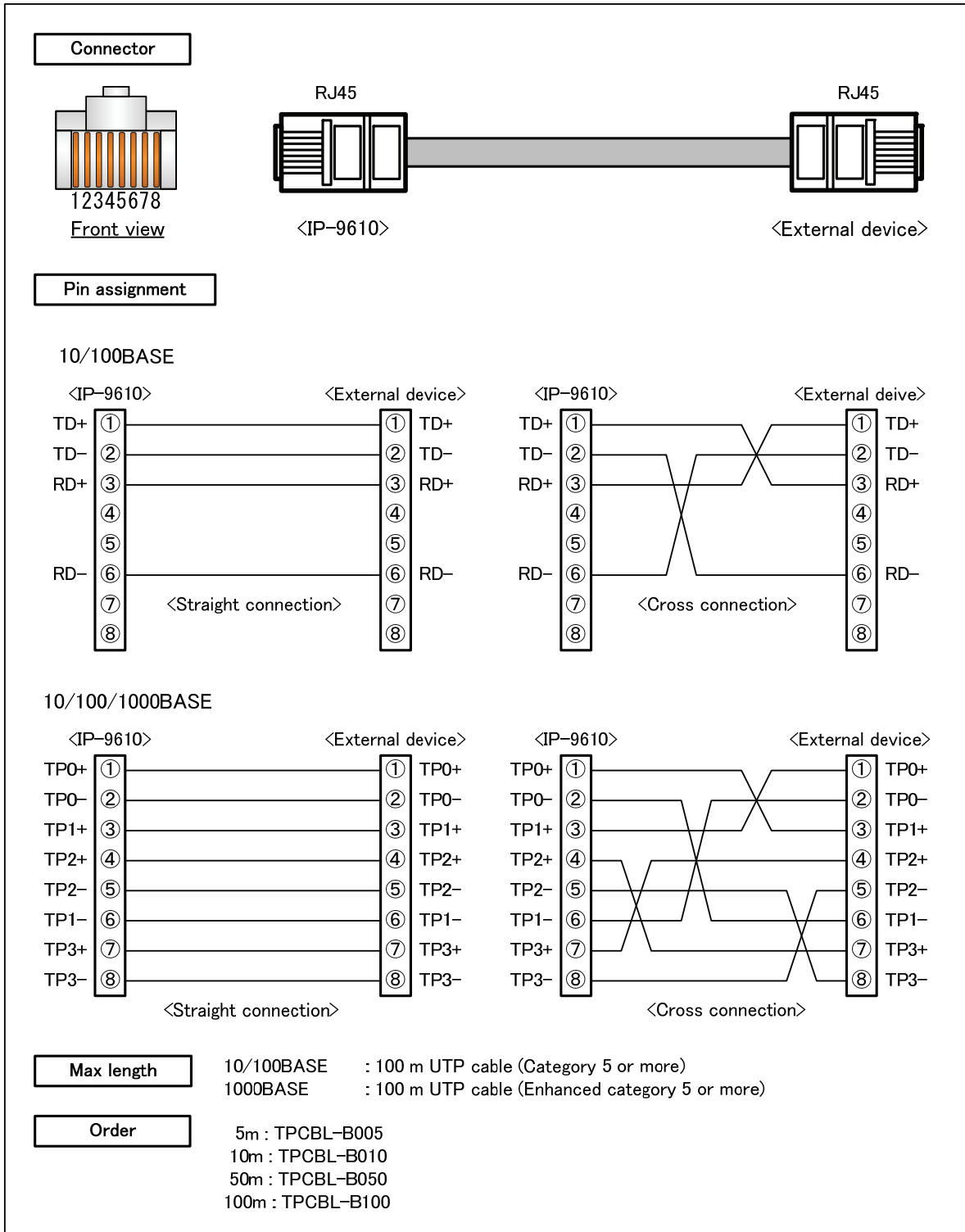

(8) Intercom adapter cable

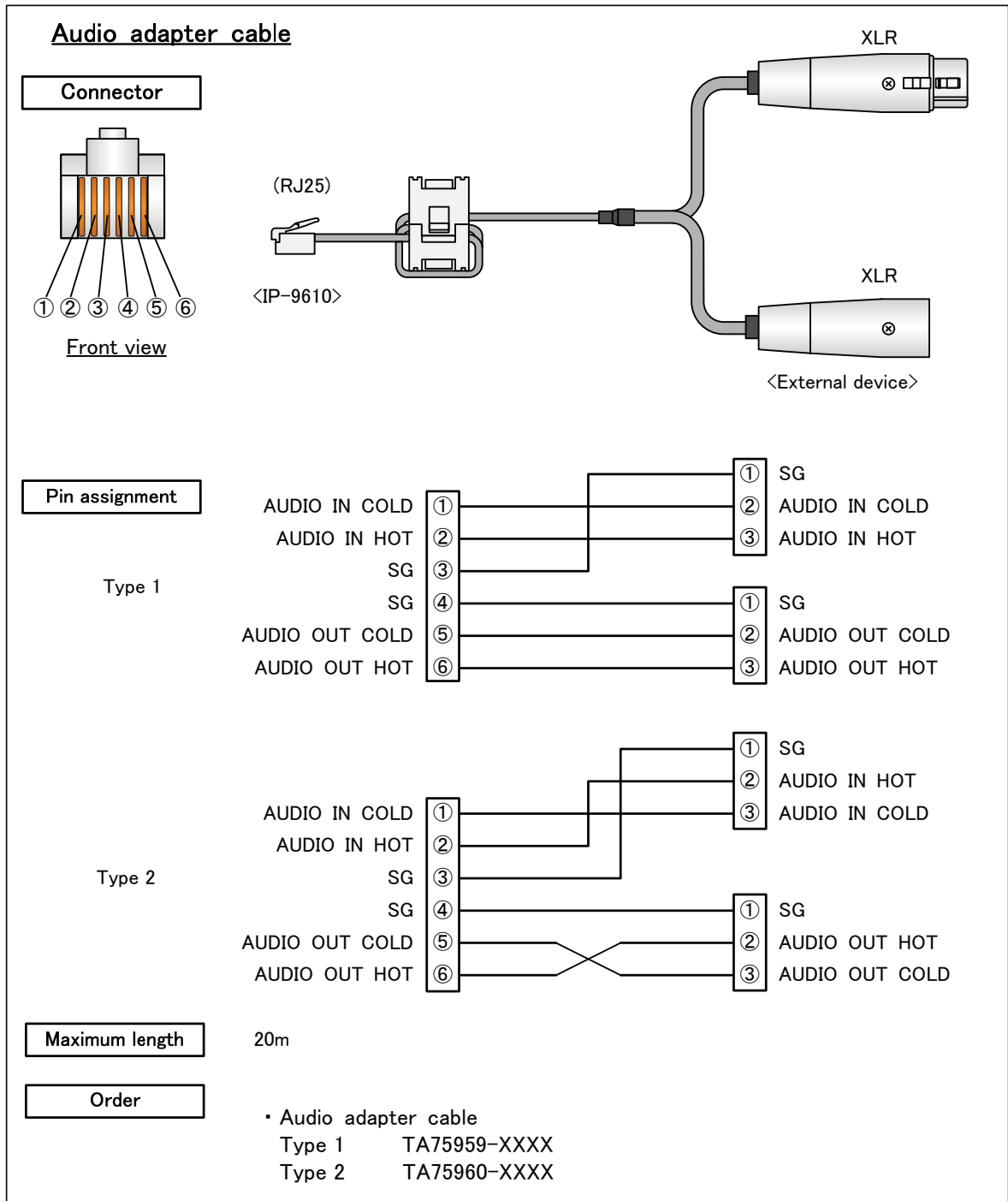





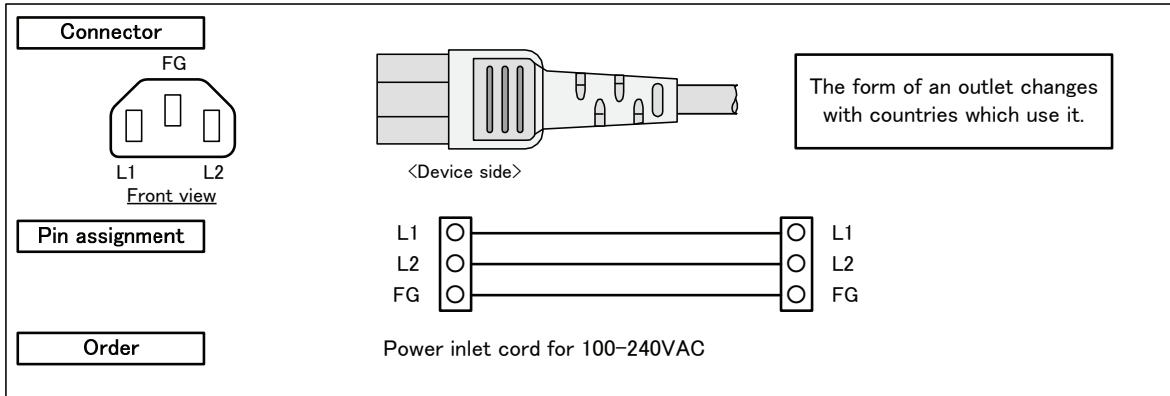













(9) 100 - 240 VAC power cord

The power supply cord is not contained in this device. Please prepare the cable which suits the country which uses it.













USABLE DETACHABLE POWER SUPPLY CABLE SET

MODEL	Input	Connector	Cord	Attachment Plug cap
North America <*1> <*2>	100-120V	IEC C-13 Rated 13A, 125V UL, CSA Approved 	Type SJT, No.16 AWG Min. 3-Conductors (Single phase;2-current carrying conductors & ground) UL, CSA Approved	NEMA (5-15P) parallel blade Rated 13A, 125V UL, CSA Approved 
	200-240V	IEC C-13 Rated 15A, 250V UL, CSA Approved 	Type SJT, No.14 AWG Min. 3-Conductors (Single phase; 2-current carrying conductors & ground) UL, CSA Approved	NEMA (6-15P) tandem blade Rated 15 A, 250 V UL, CSA Approved 
Europe <*2>	100-240V	IEC C-13 Rated 10A, 250V <*1>	CENELEC OC 3X1.0 square mm<*1> <HAR>	Rated 10 A, 250 V <*1>
Australia	100-240V	IEC C-13 Rated 10A, 250V 	Cable: AS OD 3 X1.0 square mm e.g. 	Rated 10 A, 250 V 
U.K <*2>	100-240V	IEC C-13 Rated 10A, 250V 	BS OC 3 X1.00 square mm	Rated 10 A, 250 V  or 
Japan	100V	IEC C-13 Rated 13A, 125V	Type HVCTF cross section area 1.25 square mm 3-Conductors (Single phase;2-current carrying conductors & ground)	NEMA (5-15P) parallel blade Rated 13 A, 125 V
		METI Approved  or <PSE>	METI Approved  or <PSE>	METI Approved  or <PSE>

Korea	220V (Class I)	IEC 60320-1 (IEC C-13) Rated 12A, 250V 	Comply with KSC3304. Type VCTF cross section area 1.25 (0.50 or 1.00 or 2.00) square mm 3-Conductors (Single phase;2-current carrying conductors & ground) 	Comply with KSC8305. Rated 12A, 250V 
	220V (Class II)	IEC 60320-1 (IEC C-13) Rated 3A, 250V 	Comply with KSC3304. Type VCTFK cross section area 1.25 (0.50 or 0.75 or 1.00 or 2.00) square mm 2-Conductors 	Comply with KSC8305. Rated 12A, 250V 

Note: *1. Be sure that the detachable proper Supply cord has the approval of the appropriate safety agencies of the country where the equipment will be used.
*2. Cable length of above Power Supply cord shall be shorter than 4.5 m.

CERTIFICATION MARKING

Country	Agency	Certification Mark	Country	Agency	Certification Mark
Austria	OVE		Italy	IMQ	
Belgium	CEBEC		Norway	NEMKO	
Denmark	DEMKO		Spain	AEE	
Finland	FEI		Sweden	SEMKO	
France	UTE		Switzerland	SEV	
Germany	VDE				

(This page is intentionally left blank)

CHAPTER 5

TROUBLESHOOTING

This chapter describes actions to be taken if the device does not operate normally or if an alarm LED turns on.

- 5.1 Help Information..... 47
- 5.2 Alarm LED Lamp Is On 49
- 5.3 Maintenance 50

(This page is intentionally left blank)

5.1

Help Information

If a problem is found in device operation, take recommended action described in the table below, according to the applicable conditions. If the action does not solve the problem, contact a service representative.

WARNING

Possibility of electric shock
Contact your system administrator before checking the voltage of a power outlet. Otherwise, electric shock may occur.

Table 5.1 Problem descriptions and recommended actions

No.	Class	Status	Description	Recommended action	
1.	Power	Power cannot be turned on.	Is the power cord connected?	Make sure that the power cord is properly connected to the outlet.	
2.			Is the outlet voltage normal?	Measure the voltage with a tester to confirm that the voltage is normal. If another device is connected to the same outlet, check the operation of the device.	
3.	Device	The ALM LED is blinking.	Check the log information from the browser. The temperature inside the device has risen to the critical level or the fan speed has fallen.	If the ambient temperature of the device is too high, make proper arrangements to lower the ambient temperature. If there is any shielding material in the installation space, remove it. If the fan speed is low, the fan needs to be replaced. Contact a Fujitsu Service Center.	
4.			The ALM LED is on.	The device is faulty.	Troubleshoot from the control terminal. (For details, see the software manuals.)
5.			The LEDs excluding LAN and Console are on.	Is the ambient temperature of the device higher than that in the specifications?	Adjust the temperature so that the ambient temperature of the device meets the specification's condition.
	Is there any shielding material in the installation space?	Remove the shielding material.			
6.	Input	The INDWN lamp lights in orange.	Is the power to the video/audio output device (such as a camera) selected for input turned on?	Verify the power supply and operation of the video/audio output device selected for input.	
7.			Is this device correctly connected to the video/audio output device?	Check the cable connection between this device and video/audio output device.	
8.			The INDWN lamp blinks in orange.	The synchronization slipping occurs for encoder or the reference clock input fault occurs for decoder.	Make sure that the video input signal for encoder or the reference clock input signal for decoder is set correctly.

No.	Class	Status	Description	Recommended action
9.	Line	The LINK/ACT LED for the LAN port is not turned on.	Is the power to the communication destination device turned on?	Verify the power supply and operation of the communication destination device.
10.			Are the LINK LEDs on this device and the hub turned on?	If the LINK LEDs are not ON, the LAN cable is not connected. Connect the LAN cable correctly.
11.		Device setting through a LAN is disabled.	Is the IP address specified from the Web browser correct?	Specify a correct IP address from the Web browser on the control terminal.
12.			Are the network settings (IP address, subnet mask, etc.) on the control terminal PC correct?	Make correct settings by referring to the PC user's guide and OS handbook. If this device is started with the default settings made before shipment from the factory, see "Section 3.4, " Special Use of CANCEL Key," for the network settings for the control terminal PC.
13.			Is a reply received in response to a PING command issued to the IP address of the device?	If a reply is not received, turn on the power to the device while holding down the Cancel key to start the system with the default IP address (10.0.0.1) set before shipment from the factory. Confirm the IP address. If the problem persists, check the status on the LAN. For information on this startup procedure, see Section 3.4, "Special Use of CANCEL Key."

5.2

Alarm LED Lamp Is On

This section describes corrective actions to take if an alarm LED turns on.

The appropriate corrective action depends on the alarm code displayed. See Software User's Guide for information how to check the alarm log check and an example with displayed information.

In addition, LED display details are given in the following table:

Table 5.2 LED display details

Display	Description
PWR	Lights in green when the device is powered on.
RDY	Blinks in green in the operation preparation state, and lights in green in the operation state. Blinks in orange in the maintenance mode waiting state, and lights in yellow in maintenance mode.
INDWN	No LED lights in normal state. Blinks in orange in the state of audio/video/network input down or abnormal. The alarm display by this LED can select lighting, blinking, and turning off excluding the LED lighting by the temperature anomaly. For more details of the alarm log and the setting method of LED, please refer "IP-9610 Software User's Guide."
ALM	Alarm LED. Blinks or lights in orange when a device alarm occurs. Lighting, blinking, and turning off can be selected by the setting about a part of the alarm display by this LED. For more details of the alarm log and the setting method of LED, please refer "IP-9610 Software User's Guide."
LINK / ACT	Operation status LED of LAN, CONSOLE port. This LED will be turned on when LINK of Ethernet is established and it will be blinked when Ethernet packet is detected. It will be turned off when Ethernet cable isn't connected.
10/100/1000M	Linked speed information of LAN, CONSOLE port. This LED will be turned off when linked speed is 10BASE, it will be turned on when linked speed is 100BASE, and it will be blinked when linked speed is 1000BASE.

5.3

Maintenance

5.3.1 Maintenance space

When the operators do the maintenance work, the maintenance space below is required in addition to Section 2.1.4, "Installation space."

Desk-top installation:

Please allocate the space more than 1 m in front or rear for maintenance.

Rack installation:

Please allocate the space more than 1 m in front and rear for maintenance.

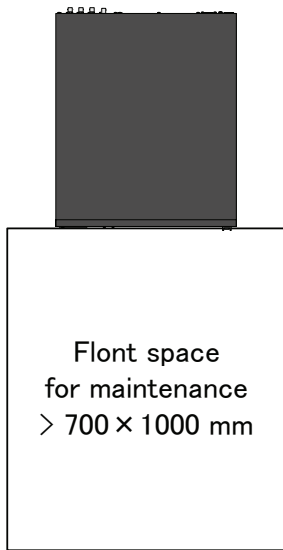

Front access case

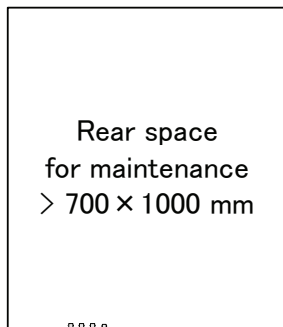

Rear access case

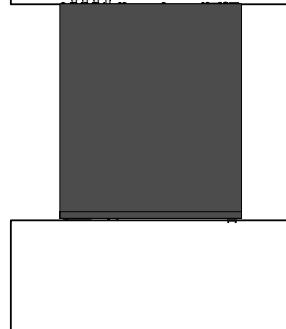
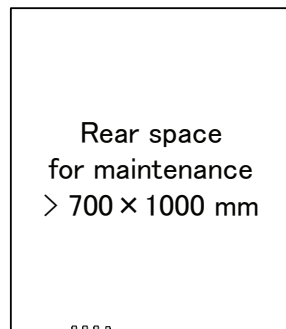

5.3.2 Change of maintenance parts (Maintenance only)

If there is no improvement of situation after checking and dealing with referring Section 5.1, “Help Information,” change the hardware following the procedure below.



This device itself is a repair unit.

In case of a malfunction, please change this device itself.

(This page is intentionally left blank)

Appendix

The appendix contains view of the device and its main specifications. Notes on installation work and preparations for on-site turn-up are also contained in this section.

A.1	Appearance.....	55
A.2	Basic Specifications	57
A.3	Preparations for Installation Work	62
A.4	Preparations for On-site Turn-up.....	63

(This page is intentionally left blank)

A.1

Appearance

The appearance of IP-9610 is shown below.

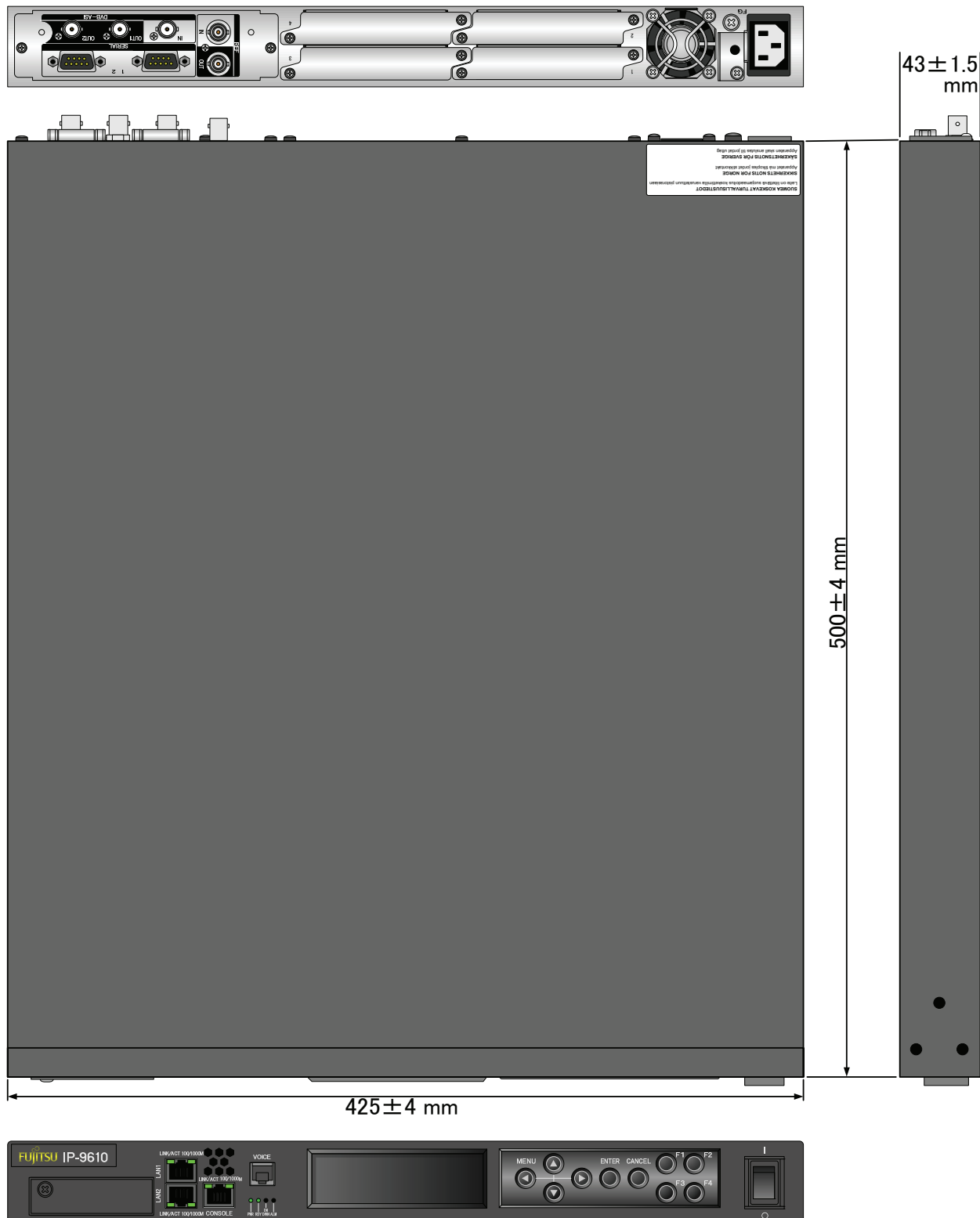

IP-9610

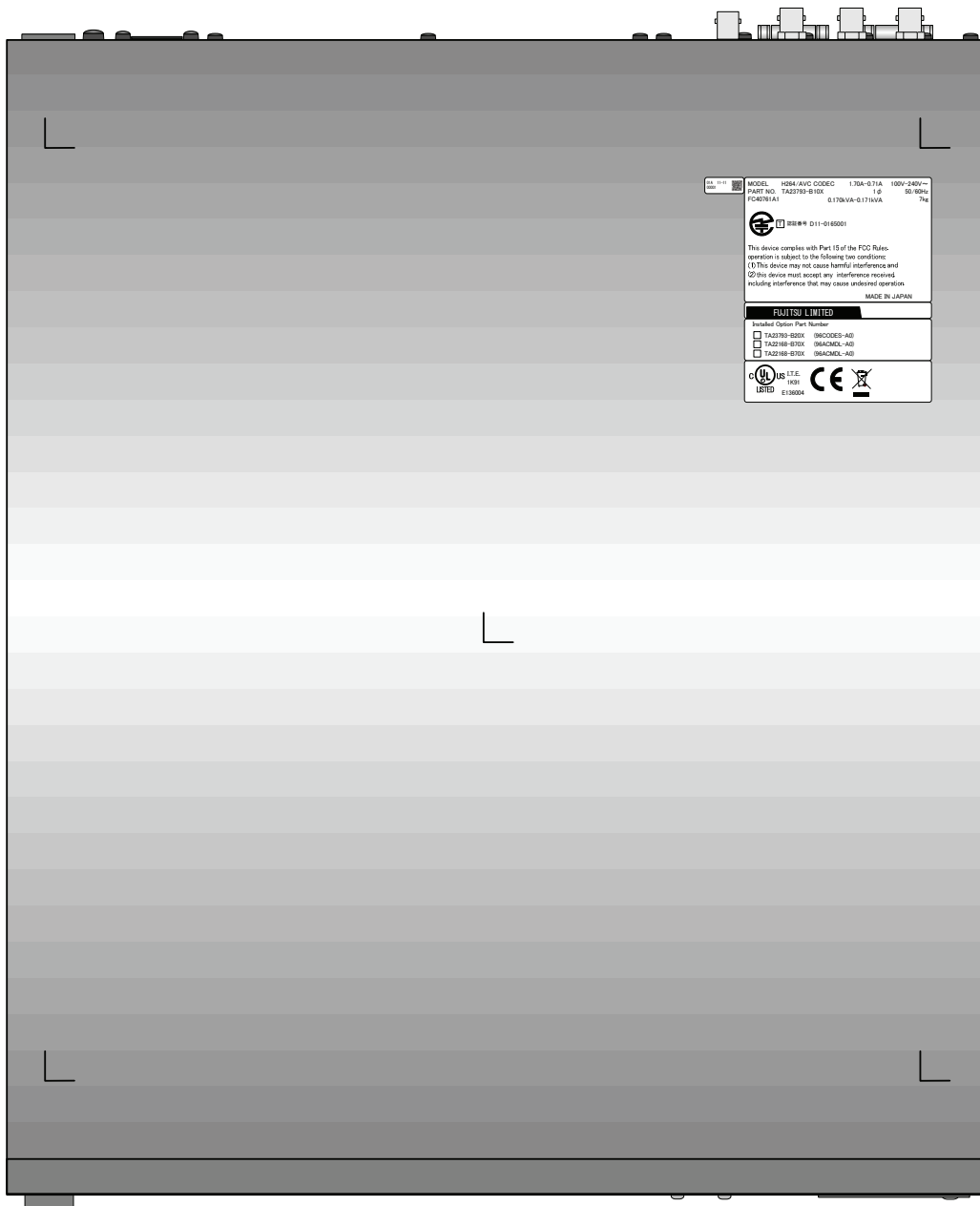

Bottom View

A.2**Basic Specifications**

This chapter describes the external specifications, environment specifications, and function specifications of the device.

A.2.1 External specifications

The device has the following external specifications:

Item	Specifications
Installation conditions	Indoor: Installation on a desk or in a rack that is mounted
Dimensions	Width: 425, Height: 43, Depth: 500 (mm) (Excluding protrusions) Width: 425, Height: 46, Depth: 520.3 (mm) (Including optional board, etc)
Cooling method	Forced air cooling (maintenance-free fan used)
Power	100-240VAC
Weight	Max. 7 kg
Power consumption	170 VA or less (100V AC) 171 VA or less (240V AC)

A.2.2 Environment specifications

The device has the following environmental specifications:

Item	Specifications
Power conditions	100-240 VAC \pm 10%, 50/60 Hz \pm 3 Hz
Temperature and humidity conditions	Temperature: 0 to 50°C Humidity: 20 to 90% (without condensation) (Conditions for guaranteed operation and characteristics)
Dust	Communication equipment room or office environment (0.2 mg/m ³ or less)
EMI (Electro Magnetic Interference - regulation)	FCC (part 15) Class A EN55022 Class A VCCI Class A

A.2.3 Function specifications

This chapter describes functional specifications of individual parts of the device.

<Main Component>

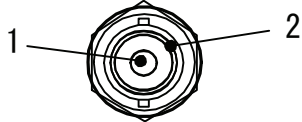
Name	Specifications		Remarks
DVB-ASI input	Signal format: NRZI Input impedance: 75Ω (Unbalanced) Minimum signal amplitude: 200mVp-p Maximum amplitude level: 800mVp-p ± 10%		
Connector name	SDI IN		BNC
Pin number	Signal name	Remarks	
1	SIGNAL		
2	SG		

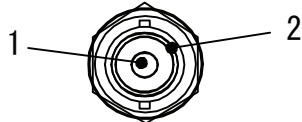
Name	Specifications		Remarks
DVB-ASI output	Signal format: NRZI Output impedance: 75Ω (Unbalanced) Signal amplitude: 800mVp-p Maximum amplitude level: 800mVp-p ± 10%		
Connector name	SDI OUT		BNC
Pin number	Signal name	Remarks	
1	SIGNAL		
2	SG		

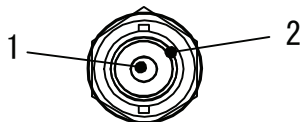
Name	Specifications		Remarks
Reference clock output	Signal format: NTSC w/o SETUP (Analog composite, 29.97frames/s) PAL (Analog composite, 25frames/s) Output impedance: 75Ω (Unbalanced) Signal amplitude: 1.0 Vp-p		NTSC/PAL Black burst
Connector name	REF OUT		BNC
Pin number	Signal name	Remarks	
1	SIGNAL		
2	SG		

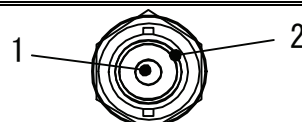
Name	Specifications		Remarks
Reference clock input	Signal format: NTSC w/o SETUP (Analog composite, 29.97frames/s) NTSC w/ SETUP (Analog composite, 29.97frames/s) PAL (Analog composite, 25frames/s) HD Tri-SYNC (29.97/25frames/s) Input impedance: 75Ω (Unbalanced) Signal amplitude: 1.0 Vp-p		NTSC/PAL Black burst or Y/Pb/Pr Three values sync (Black)
Connector name	REF IN		BNC
Pin number	Signal name	Remarks	
1	SIGNAL		
2	SG		

Name	Specifications	Remarks
Data interface (RS-232C)	No. of CH : 2 ch Signal system : Asynchronous Connection : DTE Bit rate : 1200, 2400, 4800, 9600, 19200, 38400 bps Data length : 8 Parity : NONE Stop bit : 1 flow control : NONE / RS,CS DTR signal monitoring : Enable / Disable	RS-232C interface

Connector name	SERIAL	D-sub 9 pin(male)
Pin number	Signal name	Remarks
1	CD	Carrier Detect
2	RD	Receive Data
3	SD	Send Data
4	DTR (ER)	Data Terminal Ready
5	SG	Signal Ground
6	DSR (DR)	Data set Ready
7	RTR (RS)	Request to Send
8	CTS (CS)	Clear to Send
9	RI	Ring Indicator

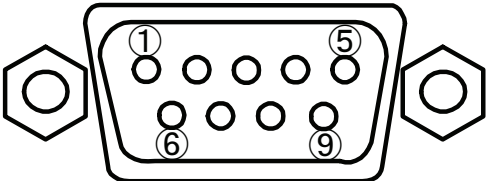

Name	Specifications	Remarks
Data interface (RS-422)	No. of CH : 2 ch Signal system : Asynchronous Connection : DTE Bit rate : 1200, 2400, 4800, 9600, 19200, 38400 bps Data length : 8 Parity : NONE Stop bit : 1	RS-422 interface

Connector name	SERIAL	D-sub 9 pin(male)
Pin number	Signal name	Remarks
1	RxD_N	Receive Data N
2	RxD_P	Receive Data P
3	TxD_N	Transmission Data N
4	TxD_P	Transmission Data P
5	SG	Signal Ground
6	—	—
7	—	—
8	—	—
9	—	—

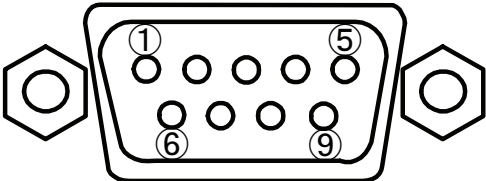

Name	Specifications	Remarks
Analog AUDIO input /output (VOICE)	Signal format: Analog audio Input / output impedance: 600Ω (Balanced) Maximum amplitude level: 20dBm , 0dBm	
Connector name	VOICE	RJ25
Pin number	Signal name	Remarks
1	IN COLD	
2	IN HOT	
3	SG	
4	SG	
5	OUT COLD	
6	OUT HOT	

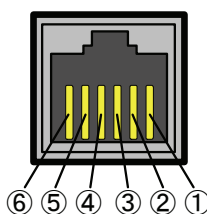

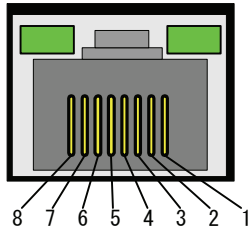
Name	Specifications				Remarks
LAN interface	[10BASE-T] System standard: IEEE802.3 Transmission clock: 10Mbit/s±10000ppm(±0.01%) Load impedance: 100Ω Transmission coding: Manchester coding				
	[100BASE-TX] System standard: IEEE802.3u Transmission clock: 125 Mbit/s±5000ppm(±0.005%) Load impedance: 100Ω Transmission coding: 4B5B				
	[1000BASE-T] System standard: IEEE802.3ab Transmission clock: 1000 Mbit/s±10000ppm(±0.1%) Load impedance: 100Ω Transmission coding: 8B1Q4				
Connector name	10/100 BASE CONSOLE		10/100/1000 BASE LAN		RJ-45
Pin number	Signal name	Remarks	Signal name	Remarks	
1	TD+	Trans. data+	TP0+	Pair 0+	
2	TD-	Trans. data-	TP0-	Pair 0-	
3	RD+	Reciv. data+	TP1+	Pair 1+	
4	N.C.	-	TP2+	Pair 2+	
5	N.C.	-	TP2-	Pair 2-	
6	RD-	Reciv. data-	TP1-	Pair 1-	
7	N.C.	-	TP3+	Pair 3+	
8	N.C.	-	TP3-	Pair 3-	
Cable	Standard: ANSI/TIA/EIA568A CAT5 Pin assignment: Comply with one of two below Pin No. 1 2 3 4 5 6 7 8 T568A W/G G W/O Bl W/Bl O W/Br Br T568B W/O O W/G Bl W/Bl G W/Br Br [W: white, G: green, O: orange, Bl: blue, Br: brown]				

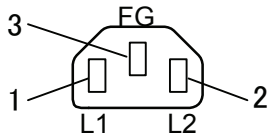
Name	Specifications			Remarks
POWER	Parallel 2 pin with ground			
	Input voltage	: 100-240VAC±10%		
Connector	: Inlet			
Button	: Locker button			
Input protection	: Built-in fuse			
Withstand voltage	: 1,500 VAC			
Connector name				
Pin number	Signal name	Remarks		
1	L1			
2	L2			
3	FG			

LED name		ON	Blinking	OFF	Remarks
PWR	G	Power ON	---	Power OFF	
RDY	G	Normal operation	Starting up	Software inactive	Blink interval: 0.5s Maintenance mode (Cancel button startup): LAN subnet mask (255.0.0.0) CONSOLE subnet mask (255.255.255.252)
	O	Maintenance mode LAN1 (IP=10.0.0.1) LAN2 (IP=10.0.0.2) CONSOLE (IP=192.168.255.253)	Maintenance mode starting up		
ALM	R	Equipment alarm	Equipment alarm	Normal operation	When the device alarm is generated, a part of alarm can be changed to lighting, blinking, and turning off by the setting.
IN DWN	O	Video/Audio/Network input down/fault	Video/Audio/Network input down/fault	Normal operation	The alarm display by this LED can select lighting, blinking, and turning off excluding the LED lighting by the temperature anomaly.
LINK/ACT [LAN1]	G	LINK established	LAN packets detection	Cable disconnection	
100M/1000M [LAN1]	G	100BASE operation	1000BASE operation	10BASE operation	
LINK/ACT [LAN2]	G	LINK established	LAN packets detection	Cable disconnection	
100M/1000M [LAN2]	G	100BASE operation	1000BASE operation	10BASE operation	
LINK/ACT [CONSOLE]	G	LINK established	LAN packets detection	Cable disconnection	
100M/1000M [CONSOLE]	G	100BASE operation	1000BASE operation	10BASE operation	

G: Green, O: Orange, R: Red

Name	Button type	Specifications	Behavior
POWER	Locker button	Power ON/OFF	

A.3

Preparations for Installation Work

This section contains notes and describes check items for installation work.

A.3.1 Scope of installation work

For details about the scope of installation work, see Section 4.1, “Installation Preparations.”

A.3.2 Unpacking and device check

Unpack and check the device as follows:

- During unpacking, carefully handle the device so as not to apply shock to it or damage its appearance.
- Make sure that the device and accompanying package are not damaged.
- Make sure that wiring does not have a short circuit and is not disconnected.
- Make sure that no incorrect screw is contained in the package.

A.3.3 Installation conditions

For the classification of this work, see Section 2.1, “Installation Conditions.”

The installation method may differ depending on the site where the device is installed. In principle, the installation method conforms to the appropriate method for the site.

Do not install the device at the following locations:

- Place exposed to direct sunlight or near a heater.
- Humid or dusty place
- Place where the device is exposed to shock or vibration
- Unstable place, such as on a slope or place with a lot of weight on it
- Place where the device is subject to strong magnetic and radio waves

A.3.4 Connecting external cables

Refer to Chapter 2, “Installation and Connection,” for the connection methods, Section 4.2, “Cables and Connector Details,” and A.2.3, “Function specifications,” for device connector pin assignments.

A.4

Preparations for On-site Turn-up

This chapter explains the workflow of on-site turn-up.

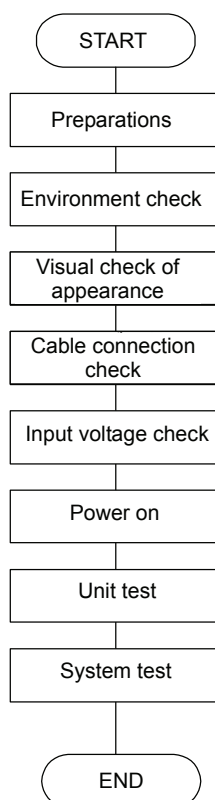

Since system configurations of the device are diverse depending on the applications used, this chapter describes the checking process for only a single device.

(1) Preparations

- 1) Check the system configuration
Check the entire system configuration.
- 2) Check the units and cables to be connected to the device
Check the units to be connected to the device, cables that have to be procured, and installation conditions.
- 3) Tools and measuring instruments necessary for work:
 - Digital multimeter
 - General-purpose tools

(2) Environment check

- 1) Ambient air temperature, humidity and power supply
Make sure that the ambient air temperature, the humidity and power supply conform to A.2.2, “Environment Specifications.
- 2) Ground connection (FG)
Make sure that use a grounding resistance of 100 ohms, a wire of 2mm² or thicker, or your country’s applicable standard.

(3) Visual check of appearance

- 1) Make sure that the device surface has no damage such as scratches, dirt, rust, deformation or peeling of its coating.
- 2) Make sure that patent nameplate and device nameplate are still attached, and that buttons are not damaged.
- 3) Make sure that connectors are not loose.

(4) Cable connection check

Make sure that individual cables are connected as prescribed in system specifications. Refer to Chapter 2, “Installation and Connection,” for the connection methods, Section 4.2, “Cables and Connector Details,” and A.2.3, “Function specifications,” for device connector pin assignments.
Hardware settings need not be set in the device.

(5) Input voltage check

Make sure that the voltage of power supplied to the device is in a range of 100-240 VAC ± 10%.

(6) Power on

- 1) Set Power button on the front panel to [ON].
- 2) Make sure that that PWR LED lamp on the front panel is on.

(7) Unit test

- 1) Since this device executes a self-check immediately after power is turned on, make sure that the RDY LED on the front of the panel does not light after power is turned on.
- 2) The LEDs light if the self-check detects an unusual condition.

(8) System test

- 1) Set-up check
Various devices settings complying with the system specification are made from the control terminal either directly or via the network.
- 2) Input video check
Make sure that the video input to the device is correctly output to the monitor (television).
- 3) Data communication check
Make sure that the line used by the system is connected.
- 4) Status check
After the final setup, when the equipment is in the system operation state, make sure that the device status LED (RDY) on the front of the device lights in green, and that the alarm LED (ALM) is off.

(This page is intentionally left blank)



Glossary and Index

Glossary 69
Index 72

(This page is intentionally left blank)

Glossary

AES/EBU

This is the standard of the professional digital audio signals and standardized by AES and EBU. ANSI adopts it too.

Alarm Log

Record of errors that have occurred on devices and communication lines

BNC (Bayonet Neill Concelman)

Type of coaxial connector whose characteristic impedance is 75 Ω . A locking system called a bayonet lock is used, ensuring cables are easy to connect and remove, and secure connections. The connector is compact and lightweight and has a frequency range compatible with the high frequency of 4 GHz, so it can be used for measuring instruments and digital audio equipment.

Browser

General name for programs that support users who want to select desired options from available options. Using a browser, a user can trace links on the Internet to access such multimedia information as text, audio, and video by simply using a pointing device (e.g., mouse) to select items.

DCE (Data Circuit terminating Equipment)

Data circuit terminating equipment. DCE is a term from ITU-T. Similar to modems and DSUs, it changes signals to waveform that are suitable for their transmission routes.

DHCP (Dynamic Host Configuration Protocol)

This is the protocol to assign IP address dynamically when startup and to release it when shutdown. The IP address prepared by DHCP server is assigned.

DTE (Data Terminating Equipment)

Data terminating equipment. It is one kind of terminal equipment (e.g., PC). DTE is a term from ITU-T and is paired with DCE.

DVB-ASI (Digital Video Broadcasting - Asynchronous Serial Interface)

This is the standard interface in DVB (Digital Video Broadcasting: European Digital Broadcasting standardization organization) and used in MPEG CODEC most commonly. It is the asynchronous serial interface and standardized in ETSI 101 891.

Embedded Audio

It is the scheme to embed (multiplex) AES/EBU digital audio signals in the auxiliary data area (blanking area) of the serial digital signal.

FG (Frame Ground)

Ground for a cabinet

Flow Control

Procedure for controlling the flow of data between two devices. Its purpose is to prevent data loss when the device buffer becomes full.

Gateway

Equipment that connects network systems that use different protocols. It basically converts one protocol into another to support operation between two networks. In a broader sense, a gateway sometimes means a device that transfers information between any two networks.

HD-SDI (High Definition television – Serial Digital Interface)

HD-SDI is the serial digital interface to transmit HD (High Definition) video signal, which transmission rate is 1.485 Gbps. It can transmit multiplexing HD video signal, PCM audio signal and data signal like time stamp.

H.264

This is one of the video compression coding systems standardized in ITU (International Telecommunication Union) in May, 2003. It is also standardized as a part of MPEG-4 (MPEG-4 part 10 Advanced Video Coding) in ISO (International Organization for Standard). Therefore, it is commonly called H.264/MPEG-4 AVC or H.264/AVC, showing both of parties.

This technology is used for the various applications from the low bit rate and low resolution like the mobile TV to the high bit rate, high resolution like HDTV. It is improved that the data capacity is half comparing MPEG-2 used wide spread.

HTTP (Hyper Text Transfer Protocol)

Protocol used for sending and receiving files and other data between a WWW server and WWW browser

Hub

Concentrator required for using 10BASE-T or 100BASE-TX as a local area network (LAN) standard. Twisted-pair cables are used to connect hubs. A high-speed hub conforms to

100BASE-TX, and a switching hub has switching functions.

IP (Internet Protocol)

Protocol used between host computers to transfer packets over all of the Internet. The codes that identify the destinations and senders in packet transfers are called IP addresses. An IP address is a 32-bit code that can identify a network and host in the network. A unique IP address must be allocated to each hosts that communicates on the Internet.

IP Address

Code used for identifying a node (e.g., PC) operating using TCP/IP. This 32-bit number is divided into four 8-bit sections, and an example of this is 200.10.101.1.

IP Multicast

Technology for transmitting identical data to multiple remote destinations simultaneously using TCP/IP. An address system called class D is used for multicasting. In the class D address system, the first four bits (1110) indicate a multicast, and the remaining 28 bits specify a multicast group. Path control methods for IP multicasting are PIM and DVMRP, but no one method has become the standard yet.

LAN (Local Area Network)

Data communication system in a specific area (maximum of 6 miles or about 10 km). It provides moderate to high data transfer speeds.

LED (Light-Emitting Diode)

The IP-9610 has a power LED lamp and alarm LED lamps. The power LED lamp is lit in green to indicate the device is on. An alarm LED lamp is lit in red to indicate that an alarm has been generated.

MPEG-4

Standard for the compression and coding of color video for storage purposes, and the name of the organization promoting this standardization is used in the name of the standard. MPEG-4 handles not only regular image and voice data but also a comprehensive range of multimedia data, including computer graphics and text. It defines a flexible framework for a scalable object encoding system depending on technological developments. It has a transfer speed ranging from several tens of Kbps to several tens of Mbps (low bit rate to wide range). It is intended for low-speed

communication by general-purpose multimedia encoding systems on mobile terminals.

PING

Command supported by operating systems such as UNIX, Windows 9x, and Windows NT, and it is used in TCP/IP networks to check whether IP packets can reach or have reached their communication destinations

PPPoE (Point to Point Protocol over Ethernet)

This is the user authentication standard for the connection like PPP connection on the Ethernet network.

PS

MPEG-2 method of multiplexing audio, video, and data. It is an abbreviation of Program Stream, and it is used for transmission and storage in an error-free environment.

RS-232C

Interface standard that was mainly established by the Electronics Industry Association (EIA) for communication between data terminals and data communications equipment

RS-422

A serial communication standard is standardized by the Electronic Industries Alliance (EIA). RS-422 can make transmission robust against noise. It supports cable lengths of up to 1.2 km and communication speeds of up to 10 Mbps

SD-SDI (Standard Definition television – Serial Digital Interface)

Standard definition digital video interface standardized in SMPTE259M.

SG (Signal Ground)

Ground for signals

Subnet Mask

Mask value used for obtaining a subnet network address from an IP address. The subnet address is obtained by using an AND operation between an IP address and subnet mask.

TCP (Transmission Control Protocol)

Abbreviation of Transmission Control Protocol, which is the protocol required for direct connection to the Internet. In the OSI reference model, TCP corresponds to the transport layer and IP corresponds to the network layer. TCP has been a global standard protocol that is supported by major operating systems, including UNIX, OS/2, Windows 95, and Windows NT.

TS (Transport Stream)

The stream used in the multi-programs multiplexing, standardized in MPEG-2 systems. The transport stream offers features for error correction for transportation over unreliable media, and is used in broadcast applications and ATM telecommunication.

TTL (Time To Live)

Abbreviation of time to live, which indicates the survival time of a packet in a network. If a packet sent to a network happens to enter a loop because of a setting error on a router, it will not survive forever but will be discarded when the time specified in the Time To Live field of the IP header is reached.

UDP (User Datagram Protocol)

Abbreviation of User Datagram Protocol, which is a TCP/IP transaction protocol used for specific applications such as remote network management and naming service access

Unicast

Communication with a station at a single address (i.e., most general one-to-one communication)

UTP Cable

Abbreviation of unshielded twisted pair. It is a unshielded pair of wires twisted together, and these wires are used for Ethernet cabling and other purposes.

VFD

Vacuum Fluorescent Display. Because VFD emits by itself, the contrast is clear rather than LCD. Wide temperature range for operation makes less influence to functions.

10BASE-T

LAN that uses unshielded twisted-pair (UTP) cables and complies with the IEEE 802.3 standard. A 10BASE-T connection uses a concentrator called a hub. It is widely used because special cabling work is not necessary and wiring can be done easily. The maximum length of cable wiring is 100 m.

100BASE-TX

One of the 100BASE LAN standards (also called Fast Ethernet), it supports a transfer rate of 100 Mbps. Other 100BASE standards are 10BASE-T4 and 100BASE-FX, and the difference is the type of cable used. 100BASE-TX uses unshielded twisted-pair (UTP) cables. It also uses the RJ-45 connector, which is similar to the modular jacks used for telephones.

1000BASE-T

One of the Gigabit Ethernet standards. It standardized as IEEE802.3ab in 1999, uses the UTP cables of the category 5 (CAT5) and the enhanced category (CAT5e). The maximum transmission distance is 100m and it supports the topology of the hubbing, star and so on.

3G-SDI

A family of interfaces used in the high-definition video transmission required for 1080p and digital cinema. With a transmission capacity as high as 3 Gbps, 3G-SDI enables transmission of 1080/60p signals through a single BNC cable.

Index

1

1000BASE-T	3, 7, 26, 60
100-240VAC	3, 21, 57, 60
100-240VAC power cord	42
100BASE-TX	3, 7, 26, 60
10BASE-T	3, 7, 26, 60

A

Alarm LED	8
Alarm LED lamp	49
Analog AUDIO input /output	59
Appearance	55
Appendix	53
Audio board	4
Audio input	3
Audio output	3
AV input status LED	8

B

Basic application examples	6
Basic specifications	57
BNC	38

C

Cable and connector details	38
Cable Specifications	35
Cancel key	8
Change of maintenance parts	51
Codec board	4
Components	5
Connecting external cables	62
Connection to DVB-ASI Device	23
Connection to DVB-ASI Input Device	23
Connection to DVB-ASI Output Device	24
Connection to External Sync(REF)	22
Connection to network	26
Connection to power source	19
Connection to RS-232C/RS-422 Device	25
Connection to Voice Communication (Intercom)	27
Cooling method	57
Cooling system	3

D

Data input/output	3
Data interface	59
Device Settings and Operation	32
Device Settings and Operation (Front Panel)	33
Dimensions	3, 57
Direction key	8
Dust	57
DVB-ASI cable	38
DVB-ASI input	9
DVB-ASI output	9

E

Enter key	8
Environment specifications	57
External specifications	57
External Sync(REF) cable	38

F

FAN	8
FG terminal	8
Function specifications	58

G

Glossary	69
Glossary and Index	67

H

Help Information	47
Humidity	3, 57

I

Index	72
Installation and Connection	11
Installation conditions	3, 13, 57, 62
Installation preparations	37
Intercom adapter cable	41
IP address	34, 48

L

LAN cable.....	40
LAN interface	60

M

Main features	3
---------------------	---

N

Network	3
---------------	---

O

Operation Instructions.....	29
Optional board slot.....	28

P

Part names.....	7
Power	57, 60
Power button.....	8
Power consumption.....	3, 57
Power inlet connector	8
Power LED	8
Power ON/OFF	31
Power supply.....	3
Power supply system connections	18
Powering off	31
Powering on	31
Preparation for installation work	62
Preparations	1
Preparations for On-site Turn-up.....	63

R

Reference clock input	3, 58
Reference clock output	3
Relay contact input	9

RS-232C.....	9, 25
RS-232C cable	39
RS-232C interface.....	59
RS-232C port	9
RS-422 cable.....	39

S

Scope of installation work.....	62
SD CARD slot.....	3, 7
SDI input board.....	4
SDI output board.....	4
Setup procedure	32
Special Use of Cancel Key.....	34
Status LED	8

T

Temperature	3, 57
Troubleshooting	45

U

Unpacking and device check.....	62
USB.....	3, 7
UTP cable.....	26

V

VFD panel.....	8, 33
Video input.....	3, 58
Video output.....	3
Voice input/output	3

W

Web browser recommended.....	32
Weight.....	3, 57

CE Conformity Information

Following address can be reached at for regarding the CE conformity information.

Fujitsu Services Limited

Address: 22 Baker Street, London, W1U 3BW, United Kingdom

URL: <http://uk.ts.fujitsu.com/support/>

IP-9610 User's Guide

November, 2011 1st Edition

© FUJITSU LIMITED

FUJITSU